

WALL MOUNTED LEAD APRON PEG RACK

PRODUCT INFORMATION

COPYRIGHT ©2025. ALL RIGHTS RESERVED



PRODUCT INFORMATION
WALL MOUNTED LEAD APRON PEG RACK

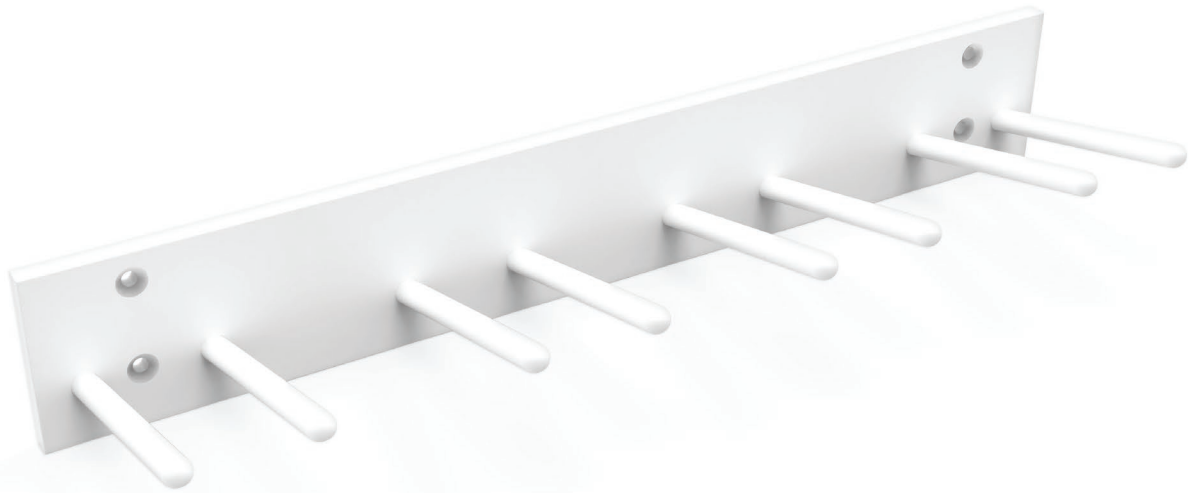

The Wall Mounted Lead Apron Peg Rack is a strong lead apron rack made of heavy gauge steel with an electro-magnetic powder coating. When securely mounted to a wall, this Phillips Safety rack can hold anywhere from 1 to 9 aprons, depending on your needs. It is available in six different sizes, for 1, 2, 3, 4, 7, or 9 lead aprons.

SPECIFICATION

COLOR: White

FEATURES: Wall mounted, eletro-magnetic powder coating

MATERIAL: Steel

LEAD APRON CAPACITY: 1 - 9

SIZE: 6 variations

WEIGHT: 2.2 lb - 18 lb

PRODUCT INFORMATION

PRODUCT INFORMATION
WALL MOUNTED LEAD APRON PEG RACK

RAR P1

FRONT

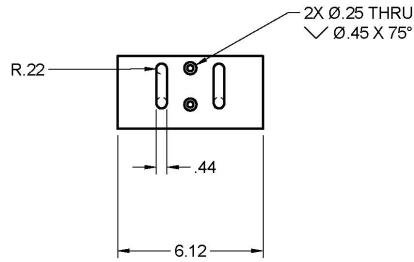

SIDE

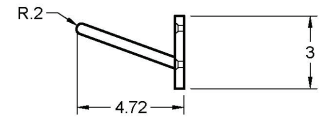

PERSPECTIVE

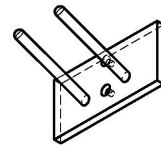

TOP

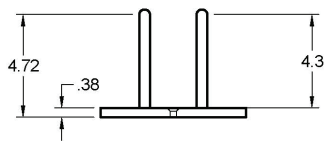

ALL THE RESPECTIVE DIMENSIONS ARE IN INCHES UNLESS SPECIFIED.	PROJECT			
	RAR P1			
	TITLE			
	PHILLIPS SAFETY PRODUCT INC			
APPROVED	SIZE	CODE	DWG NO	REV
CHECKED	1/6			
DRAWN Ryan Phillips	SCALE 3"=1"	WEIGHT 2.2LB-18LB	SHEET 1/1	

PRODUCT INFORMATION
WALL MOUNTED LEAD APRON PEG RACK

RAR P2

FRONT

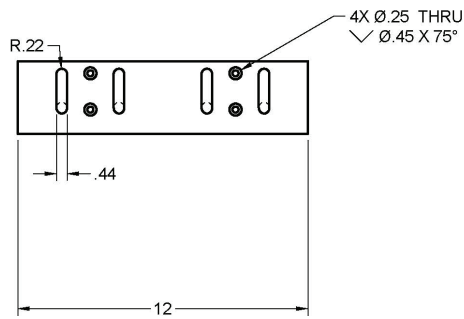

SIDE

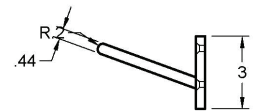

PERSPECTIVE

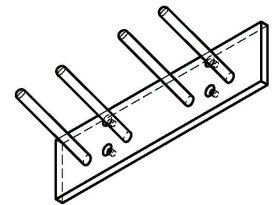

TOP

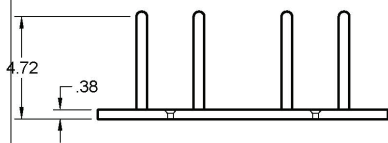

ALL THE RESPECTIVE DIMENSIONS ARE IN INCHES UNLESS SPECIFIED.	PROJECT RAR P2			
	TITLE PHILLIPS SAFETY PRODUCT INC			
APPROVED	SIZE	CODE	DWG NO	REV
CHECKED	2/6			
DRAWN Ryan Phillips	SCALE 3"=1"	WEIGHT 2.2LB-18LB	SHEET 1/1	

PRODUCT INFORMATION
WALL MOUNTED LEAD APRON PEG RACK

FRONT

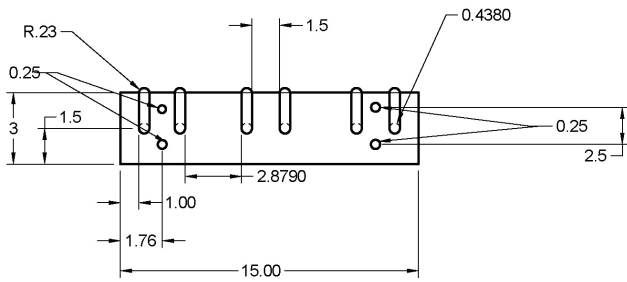

SIDE

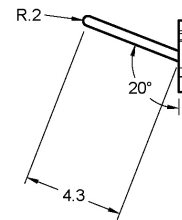

PERSPECTIVE

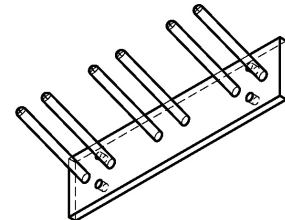

TOP

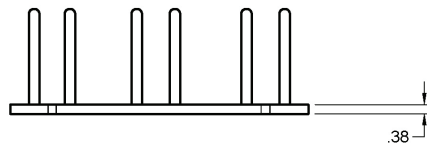

ALL THE RESPECTIVE DIMENSIONS ARE IN INCHES UNLESS SPECIFIED.		PROJECT RAR-P3 RACK			
		TITLE PHILLIPS SAFETY PRODUCT INC			
APPROVED	SIZE B	CODE	DWG NO	REV	
CHECKED					
DRAWN	Ryan Phillips	SCALE 3'=1"	WEIGHT	SHEET 1/1	

PRODUCT INFORMATION
WALL MOUNTED LEAD APRON PEG RACK

RAR P4

FRONT

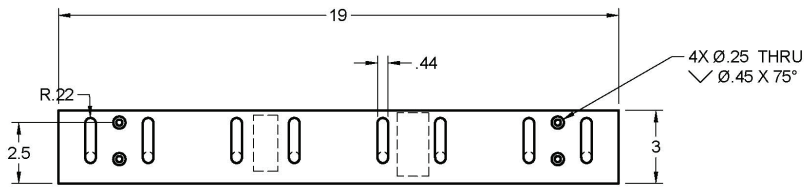

SIDE

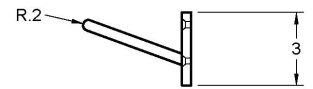

PERSPECTIVE

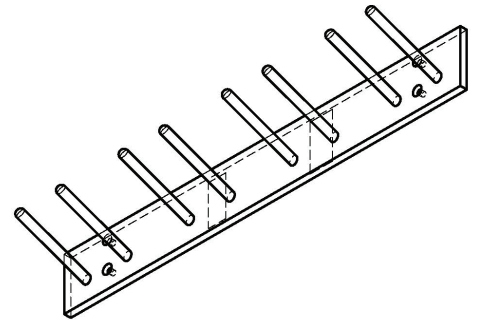

TOP

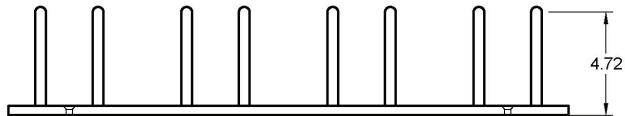

ALL THE RESPECTIVE DIMENSIONS ARE IN INCHES UNLESS SPECIFIED.	PROJECT RAR P4			
	TITLE PHILLIPS SAFETY PRODUCT INC			
APPROVED	SIZE	CODE	DWG NO	REV
CHECKED	4/6			
DRAWN Ryan Phillips	SCALE 1:4	WEIGHT 2.2LB-18LB	SHEET 1/1	

PRODUCT INFORMATION
WALL MOUNTED LEAD APRON PEG RACK

RAR P7

FRONT

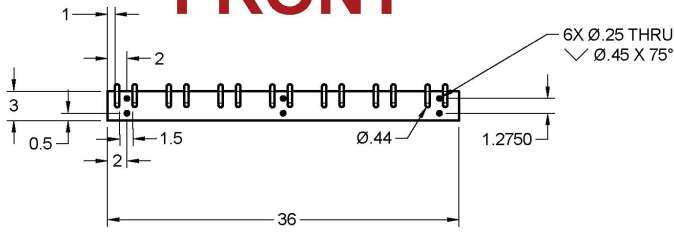

SIDE

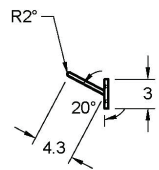

PERSPECTIVE

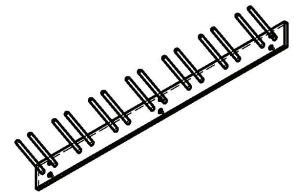

TOP

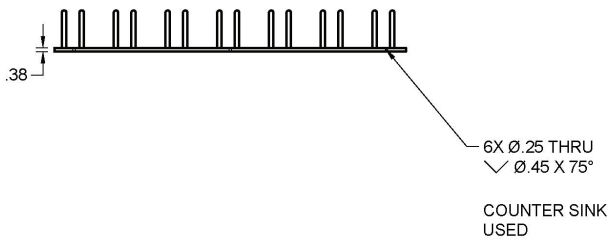

ALL THE RESPECTIVE DIMENSIONS ARE IN INCHES UNLESS SPECIFIED.	PROJECT			
	RAR-P7 RACK			
APPROVED	SIZE	CODE	DWG NO	REV
	CHECKED	5/6		
DRAWN	Ryan Phillips	5/1/2024	SCALE 3"=1"	WEIGHT 2.2LB-18LB
			SHEET	1/1

PRODUCT INFORMATION
WALL MOUNTED LEAD APRON PEG RACK

