

# Operation Manual

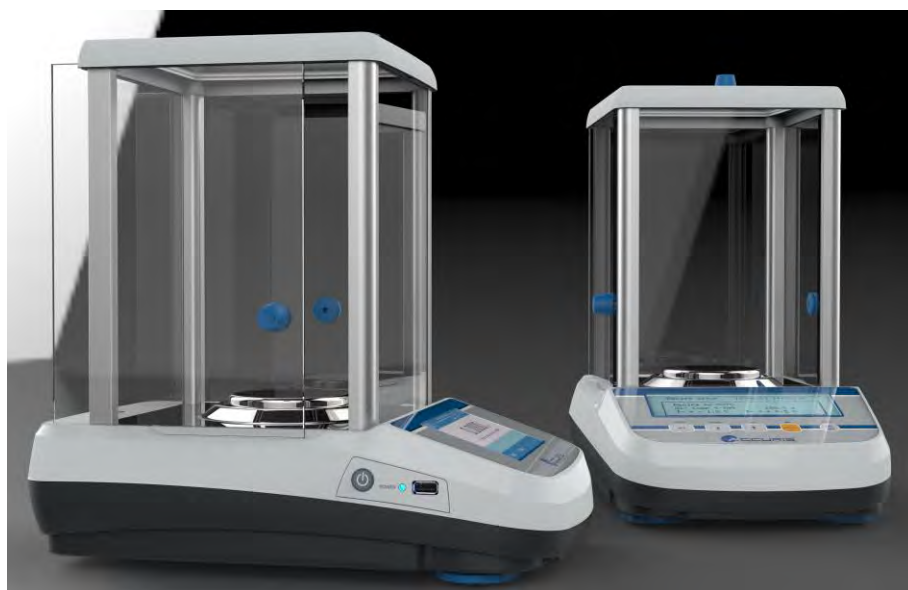

## Analytical Balance Series Dx Models W3101A-120 / W3100A-220 (graphic dot matrix display)



# Table of Contents:

<b>1</b>	<b>INSTALLATION INSTRUCTIONS</b> .....	<b>4</b>
<b>2</b>	<b>STORAGE CONDITIONS</b> .....	<b>5</b>
<b>3</b>	<b>WEIGH PAN ASSEMBLY</b> .....	<b>6</b>
<b>4</b>	<b>KEYBOARD AND DISPLAY</b> .....	<b>6</b>
<b>5</b>	<b>INPUTS OUTPUTS</b> .....	<b>7</b>
5.1	BALANCE BACK AND UNDERNEATH.....	7
<b>6</b>	<b>WEIGHING</b> .....	<b>8</b>
6.1	STAND BY.....	9
6.2	SIMPLE WEIGHING.....	9
<b>7</b>	<b>CALIBRATION</b> .....	<b>9</b>
7.1	BALANCES WITH EXTERNAL CALIBRATION.....	9
7.1.1	<i>External calibration</i> .....	9
7.2	BALANCES WITH INTERNAL CALIBRATION.....	11
7.2.1	<i>Internal calibration</i> .....	11
7.3	VERIFICATION.....	12
<b>8</b>	<b>TARE FUNCTION</b> .....	<b>13</b>
8.1	MANUAL TARE FUNCTION.....	14
<b>9</b>	<b>BALANCE PARAMETERS SETUP MENU</b> .....	<b>15</b>
9.1	WEIGHT UNITS.....	16
9.2	SERIAL OUTPUT SETUP.....	17
9.3	TRANSMISSION SPEED SELECTION.....	18
9.4	AUTOZERO FUNCTION.....	19
9.5	FILTER SELECTION.....	19
9.6	STABILITY FUNCTION.....	20
9.7	CONTRAST ADJUSTMENT.....	21
9.8	BACKLIGHT REGULATION.....	22
9.9	TIMER-OFF FUNCTION.....	23
9.10	DATE AND TIME REGULATION.....	23
9.11	LANGUAGE SELECTION.....	25
9.12	CALIBRATION MODE SETTING.....	26
9.12.1	<i>Automatic Calibration (AUT-CAL)</i> .....	26
9.12.2	<i>Internal calibration (I-CAL) [locked for verified balances]</i> .....	27
9.12.3	<i>External calibration (E-CAL) [locked for verified balances]</i> .....	28
9.12.4	<i>Technical calibration (TEC-CAL) [locked for verified balances]</i> .....	28
9.13	CALIBRATION DATA.....	29
<b>10</b>	<b>BALANCE PROGRAMS MENU</b> .....	<b>30</b>
10.1	PIECE COUNTING FUNCTION.....	30

10.1.1	Manual insertion of the average unit weight .....	32
10.1.2	Automatic updating of the average unit weight .....	34
10.2	PROGRAM FOR THE DETERMINATION OF THE DENSITY OF A SOLID OR A LIQUID .....	34
10.2.1	Solid density determination .....	34
10.2.2	Liquid density determination.....	36
10.3	FORMULATION FUNCTION .....	39
10.3.1	Manual formulation .....	39
10.3.2	Formula saving .....	40
10.3.3	Formula recall .....	42
10.4	MAX-MIN THRESHOLDS FUNCTION. ....	45
10.4.1	With both the limits set .....	46
10.4.2	With only the lower limit set.....	46
10.4.3	With only the upper limit set.....	46
10.5	PERCENTAGE WEIGHING FUNCTION .....	47
10.5.1	Automatic mode with reference weight.....	47
10.5.2	Mode with manual insertion of the reference weight. ....	48
10.6	ANIMAL WEIGHING FUNCTION .....	49
10.7	MAXIMUM LOAD FUNCTION.....	50
10.8	GLP FUNCTION (GOOD LABORATORY PRACTICES).....	50
<b>11</b>	<b>RS232 INTERFACE FEATURES .....</b>	<b>53</b>
11.1	GENERAL FEATURES .....	53
11.2	MAP OF CONNECTOR .....	53
11.3	CONNECTON OF THE BALANCE TO THE OPTIONAL ALPHANUMERIC KEYBOARD .....	53
11.4	CONNECTON OF THE BALANCE TO COMPUTER .....	53
11.4.1	Continuous Transmission mode .....	55
11.4.2	Ondemand transmission mode .....	55
11.4.3	Ondemand transmission with G.L.P. ....	57
11.5	CONNECTON OF BALANCE WITH SERIAL PRINTER .....	57
11.5.1	PRINT FORMATS .....	58
11.5.2	Generic Printer or TLP 50 printer with G.L.P. ....	59
<b>12</b>	<b>ERROR CODES.....</b>	<b>61</b>
<b>13</b>	<b>MAINTENANCE AND CARE.....</b>	<b>62</b>
<b>14</b>	<b>BALANCE TECHNICAL SPECIFICATION.....</b>	<b>ERROR! BOOKMARK NOT DEFINED.</b>
<b>15</b>	<b>WARRANTY .....</b>	<b>63</b>
<b>16</b>	<b>EQUIPMENT DISPOSAL .....</b>	<b>63</b>

# 1 Installation instructions



## WARNING:

Please carefully read these installation and use instructions before you begin using your new balance. The product's safety and accuracy cannot be guaranteed if the instrument is used in a way that is different from that recommended in this manual.

**DO NOT DISCARD THE ORIGINAL PACKAGING MATERIAL. THIS PACKAGING MUST BE USED IF THE BALANCE NEEDS TO BE RETURNED FOR SERVICE.**

- **Remove** the balance and its calibration weight (if supplied) from the carton and check for any visible damage to the instrument.
- **Do not install** the balance in environments in which there are drafts, strong temperature changes, or vibrations.
- **Do not use** the balance in potentially explosive environments.
- **The humidity of the environment** where the balance is used must be between 45% and 75%.

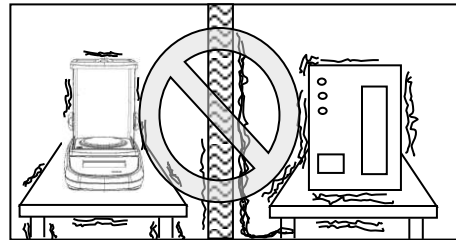
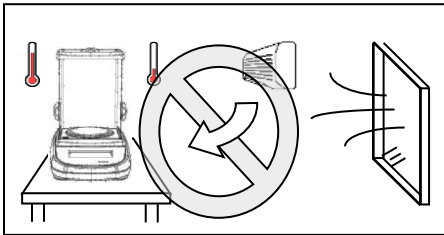

**ATTENTION**

**For models with internal calibration:** remove the protection screw in the left lower part of the balance (see Section 5)

- **Place** the weigh pan support and weigh pan on the balance (see page 6).
- **Level** the balance by adjusting the front feet. The leveling bubble will indicate that the balance is leveled properly.

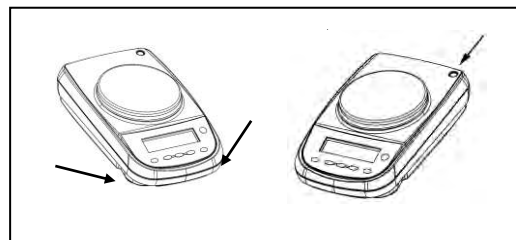
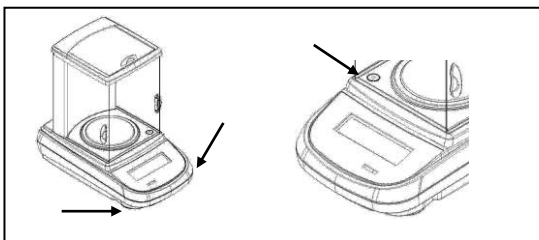

- **Connect** the power supply to the power inlet at the back of the balance (see Section 5).
- **Connect** the power supply to a nearby outlet, **which must be easily accessible**. Press the power button on the right side of the control panel to power on the balance.
- **Balance Warm-up:**
  - It is necessary to allow the balance to equilibrate to ambient conditions before use. Wait at least 8 hours after initially plugging in the analytical balance (0.0001g)

Then calibrate the balance as described in Section 7.

**It is strongly suggested not to disconnect power cord from the balance to turn it off. Use the ON/OFF button to put the balance into stand-by mode when not in use.**
- **Calibrate** the balance every time that it is moved to another location.
- **Periodically check** the balance's calibration.
- **Do not** drop objects of an excessive weight on the balance weigh pan, as doing so may damage to the weigh cell mechanism.
- **Service** should be carried out by trained personnel, and spare parts used must be original. Contact your distributor or Accuris Instruments for service.

## 2 Storage conditions

- **Storage temperature** +5 °C to +40°C
- **Storage humidity** 45% - 75%.
- **Keep the original balance packaging** in case the instrument needs to be shipped for servicing; disconnect all cables and any accessories to prevent unnecessary damage.
- **Do not expose** the balance to extreme temperatures and humidity unnecessarily, and avoid violent shocks and vibration.

### 3 Weigh pan assembly

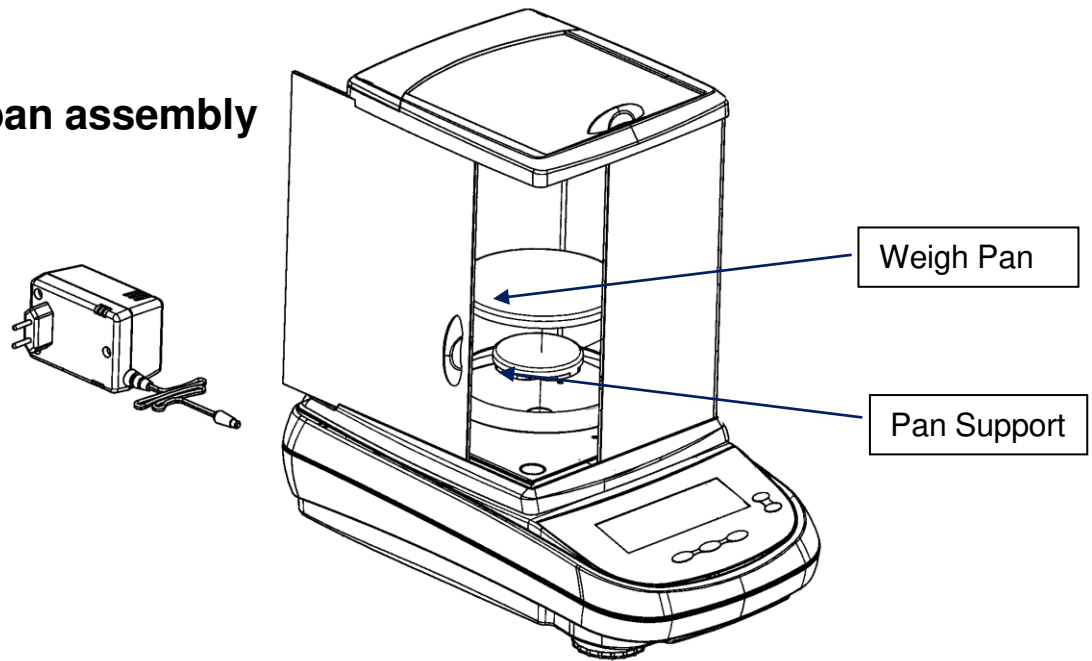

The weigh pan assembly consists of 2 pieces: the pan support piece is first gently placed onto the weigh cell, and then the weigh pan is placed gently onto the pan support.

### 4 Keyboard and display

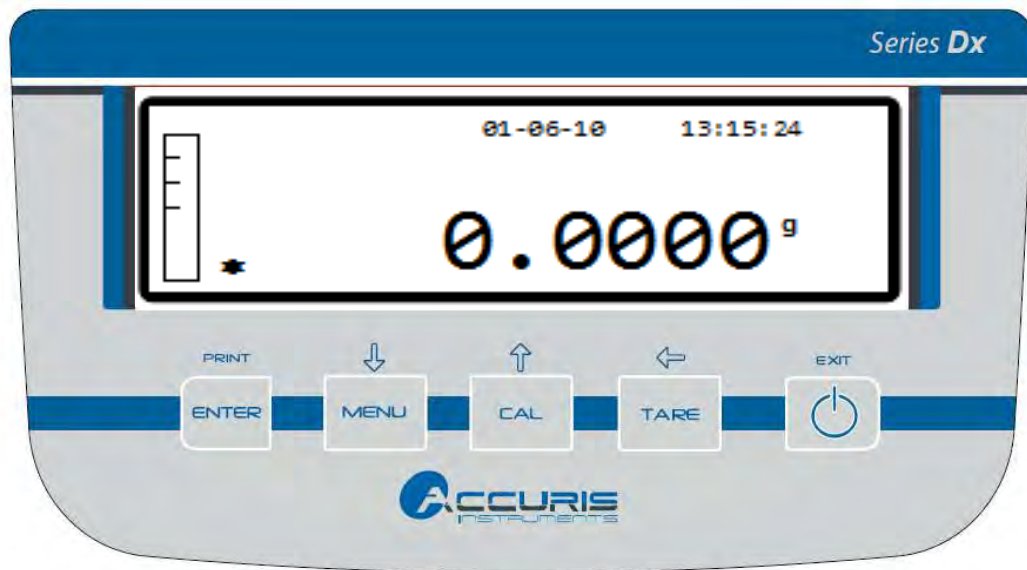

**\*** Stability indicator

**O** Zero indicator

**%** Percent weight

**PC** Piece counting

**▼** Data insertion mode

**H** Upper threshold

**L** Lower threshold

**DS** Density measurement

**Ct, ozt, lb, GN, Dwt, kg, mg, g** Unit of measurement

## 5 Inputs outputs

### 5.1 Balance Rear and Underneath

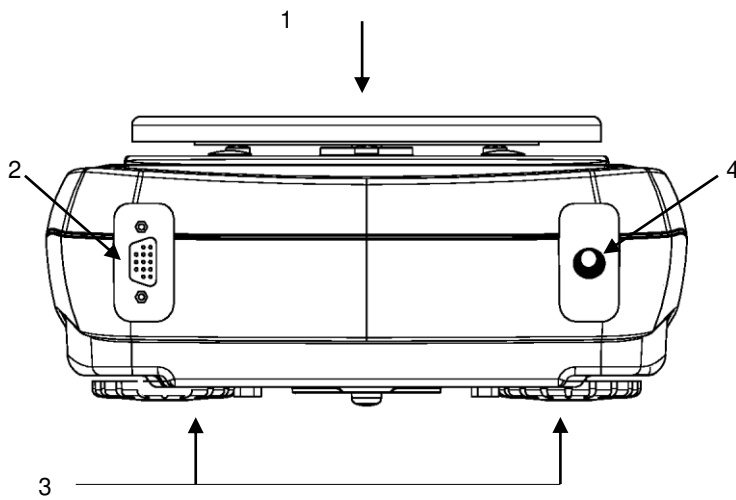

Figure 1

1. Weigh pan assembly

2. RS232, 9 pin connector for PC/keyboard and printer

3. Adjustable feet

4. Power supply input

Figure 2

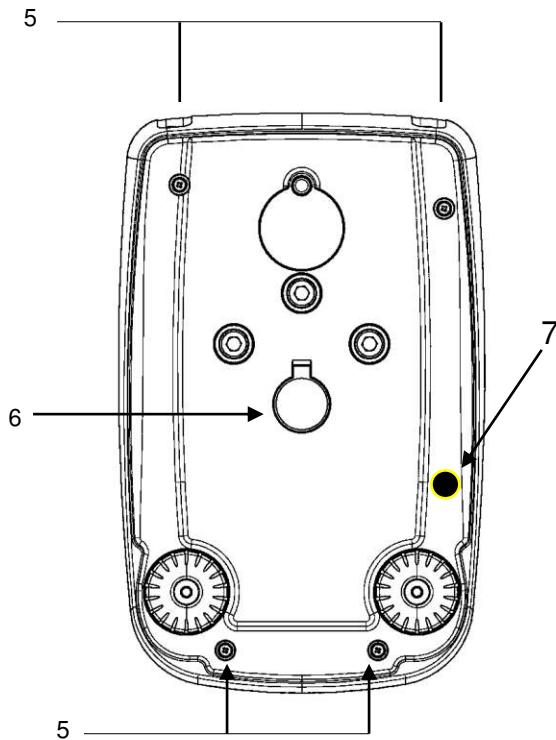

5. Balance closure screws

6. Weighing hook under the balance

Note: to access, remove the cap

7. Shipping protection screw for auto calibration motor (only for models with internal calibration).

**ATTENTION:** remove this screw by hand as soon as the balance is removed from its package

## 6 Weighing

After connecting the balance to a power outlet, a self-diagnosis of the electronic circuits is automatically carried out, and when finished “off” is displayed to indicate standby mode:





## 6.1 Stand By

From the “**STAND BY**” state:

- Press the **ON/OFF** button to bring the balance to working condition.
- Press the **ON/OFF** button again to return to the “**STAND BY**” state.



## 6.2 Simple weighing

Place the sample to be weighed on the plate and read the value of the weight on the display as soon as the asterisk stability symbol ✱ appears.

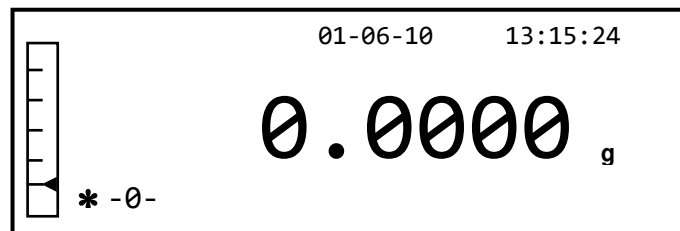

## 7 Calibration

The Accuris Analytical Balance carries out mass measurements using gravity (g). Differences in geographical regions and altitudes will affect the gravitational acceleration (g).

The balance must therefore be adapted to specific environmental conditions by calibrating to obtain accurate measurements.

### 7.1 Balances with external calibration

#### 7.1.1 External calibration

The calibration is carried out through the CAL button.

1. Press the **CAL** button with the plate unloaded; the word CAL will be displayed.

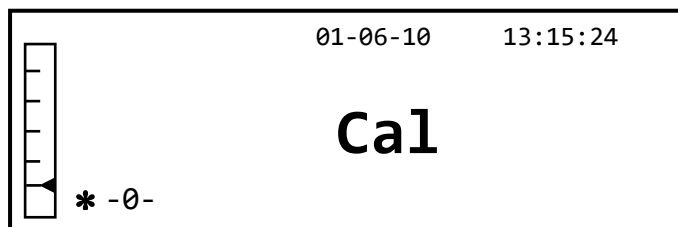

- When the value of the calibration weight begins to flash, load the weight indicated by the display on the plate.

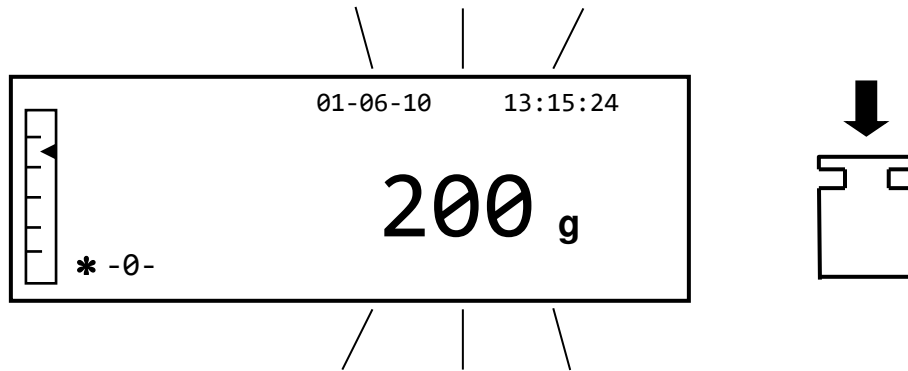

- The display will stop flashing, indicating the value of the calibration weight with the stability indicator on.  
Once the calibration has been carried out, the calibrated weight will be displayed with the indication of the current unit of measurement.
- Remove the calibration weight.  
The balance is ready for weighing operations.

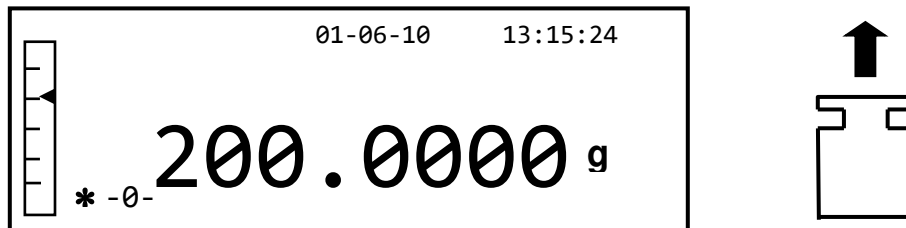

**NOTE:** an error message will be displayed if there is any interference during the calibration process. To interrupt the calibration process, press the ON/OFF button while the calibration weight indication flashes.

It is also possible to calibrate the balance with a calibration weight greater than the pre-set calibration weight:

- Press and hold the **CAL** button with the weigh pan empty until the beeping stops, and then release the button. The word “-CAL-“ is shown on the display, followed by the word “LOAD”, flashing.

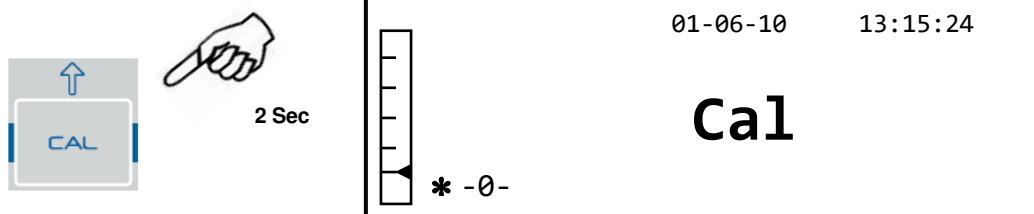

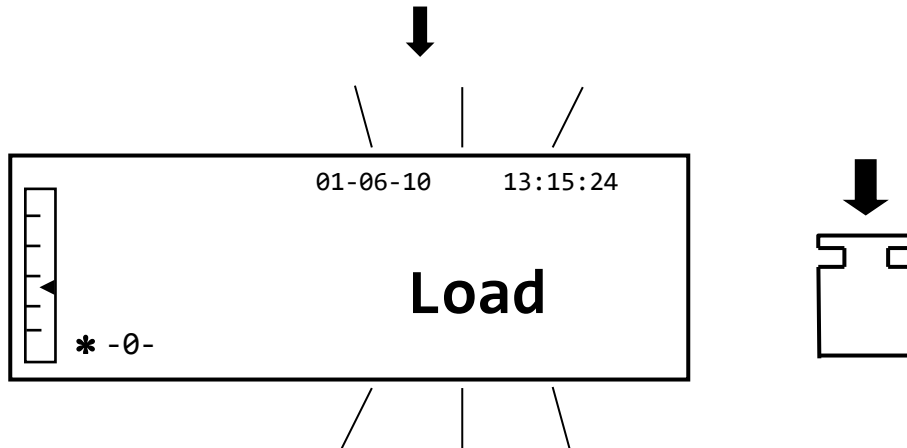

2. Load a weight that is equal to or greater than the pre-set calibration weight on the plate; the balance will recognize a weight that is equal to or greater than the calibration weight as valid provided that it is a whole weight with respect to the most significant figure of the calibration weight.  
*E.G.:* if the calibration weight is 200 g, it will be possible to calibrate the balance with values that go from 200g, 300g, 400g up to the upper capacity limit of the balance.  
 The word “**LOAD**” on the display will stop flashing; once the calibration has been carried out, the value of the weight used will be displayed.
3. Remove the calibration weight; the balance is ready for weighing operations.

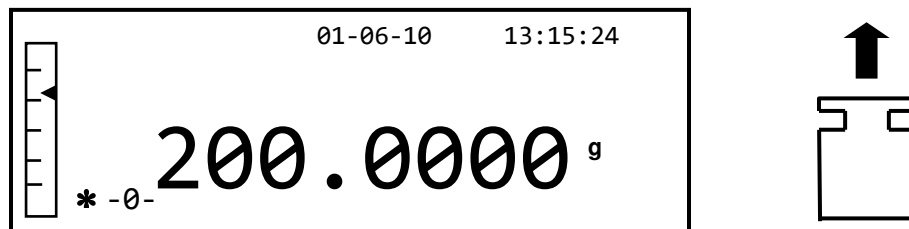

**NOTE:** an error message will be displayed if there is some interference during the calibration process. To interrupt the calibration process, press the ON/OFF button while the calibration weight indication flashes.

## 7.2 Balances with internal calibration

### 7.2.1 Internal calibration

In these models the calibration is carried out through an internal automatic system:

1. Press the **CAL** button with the weigh pan empty.  
 The display will show the message “**CAL**” and the balance’s calibration will be carried out automatically.

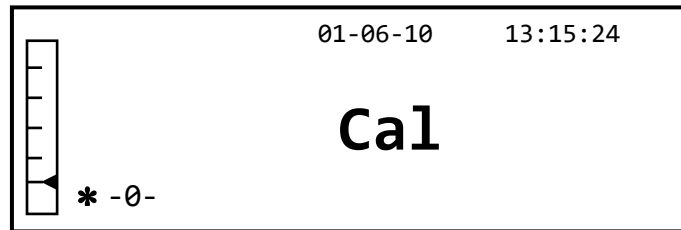
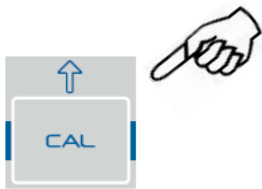

2. At the end of the calibration, the balance will return to normal weighing conditions.

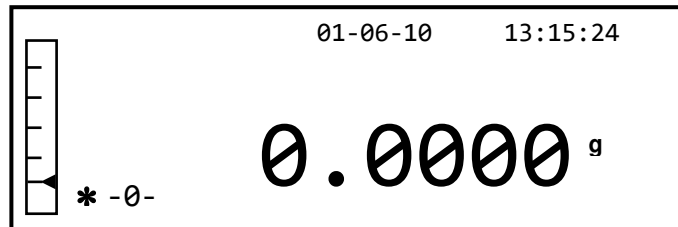

If the calibration is not completed due to vibrations or drafts, the message “**CAL bUT**” will be displayed. Press the CAL button again, and if the problem persists, select external calibration and contact the supplier.

To switch the calibration mode in these models to external calibration, see section 9.12.1

### 7.3 Verification

General introduction:

According to EU directive 90/384/EEC balances must be verified if they are used for legally controlled applications:

- a) For commercial transactions if the price of goods is determined by weighing.
- b) For the production of medicines in pharmacies as well as for analyses in the medical and pharmaceutical laboratory.
- c) For official purposes.
- d) For manufacturing final packages.

For any questions about requirements, please contact your local standards office.

#### Verification instructions

An EU type approval exists for balances described in their technical data as verifiable. If a balance is used where obligation to verify exists as described above, it must be verified and re-verified in regular intervals.

Re-verification of a balance is carried out according to the respective national regulations. The legal regulation of the country where the balance is used must be observed! After verification the balance is sealed at the indicated positions.

Verification of the balance is invalid without the "seal".

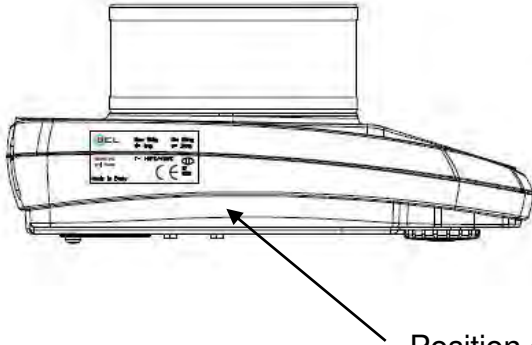

Position of the seal mark for Verified balances models

Balances with a verification requirement must be taken out of operation if:

- The weighing result of the balance is outside the error limit. Therefore, in regular intervals load balance with known test weight (ca. 1/3 of the max. load) and compare with displayed value.



- The reverification deadline has been exceeded.

## 8 Tare function (example using a weighing container)

1. The relative weight of the weighing container will be shown on the display.

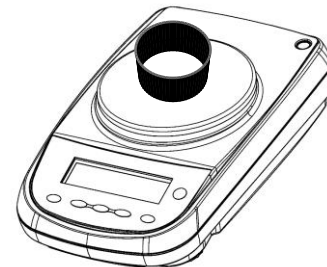
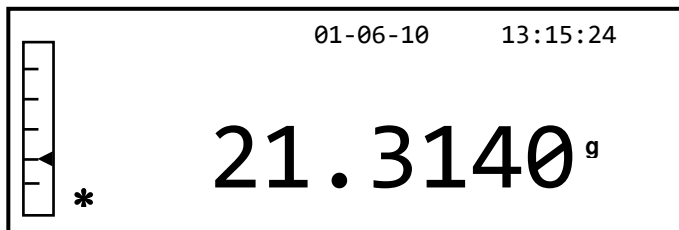

2. Press the **TARE** button. The word "Tare" will be displayed.



- Once stability has been achieved, the zero value “0.0000” will be displayed. In case stability is not achieved due to drafts, vibrations, or other types of disturbance, the dashes will continue to be displayed.

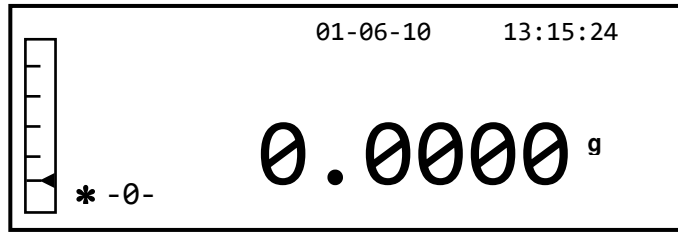

- Place the objects to be weighed in the container. Read the value of the net weight on the display.

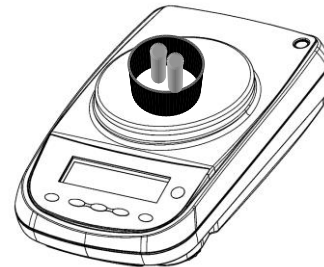
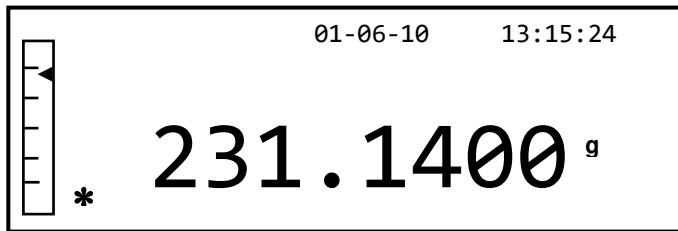

### 8.1 Manual tare function

This function allows a tare value to be entered manually.

- Press and hold the **TARE** button with the weigh pan empty until the beeping stops, and then release the button.
- “Manual tare” will be shown on the display:

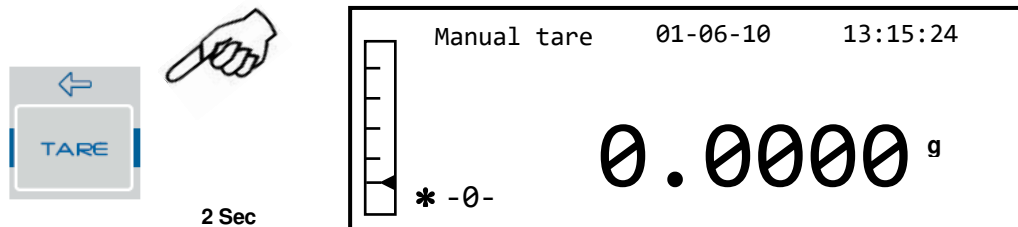

- Now insert the desired tare value using the **CAL** and **MENU** buttons to increase and decrease the number, while pressing the **TARE** button to pass to the next number. During the entering phase, holding down the **TARE** button allows you to delete the inserted value.

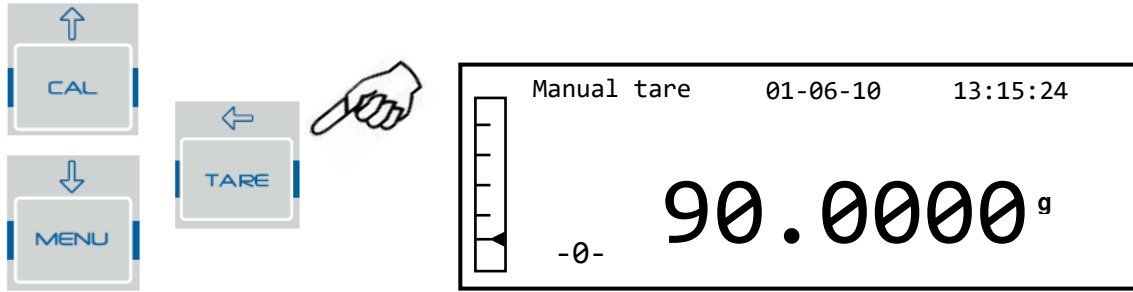

4. After having entered the desired value, press the **PRINT** button to confirm it. The value will remain in memory until the **TARE** button is pressed, or the instrument is disconnected from the power supply

## 9 Balance parameters setup menu

1. Press and hold the **MENU** button with the plate empty until the beeping stops, and then release the button.
2. The following writing will be shown on the display:

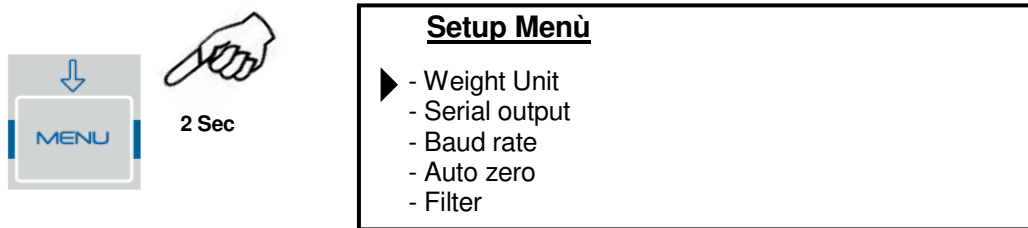

3. Now use the CAL and MENU buttons to navigate forward or backward in the parameters menu.

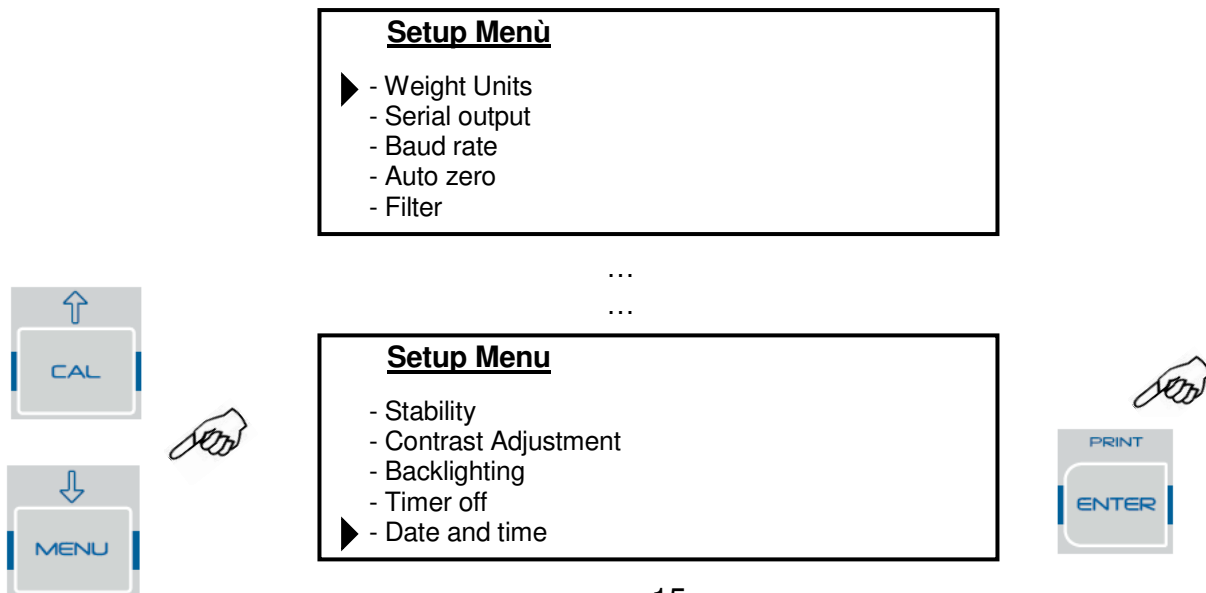

...  
...  
...

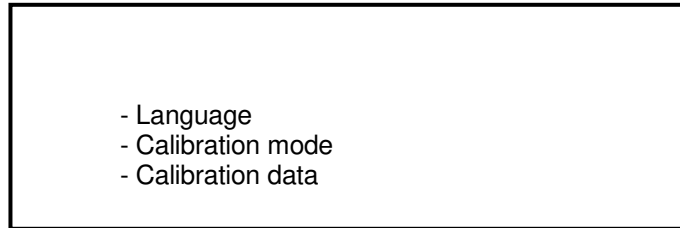

4. Position the cursor on the desired parameter and press the PRINT button to confirm the selection.
5. Press the ON/OFF button to exit from the menu or select the return function and press the PRINT button.

## 9.1 Weight Units

The weight units with which the balance will weigh can be selected.

1. Set the weight units parameter as described in chapter 10.  
The currently set weight units will be shown on the display:

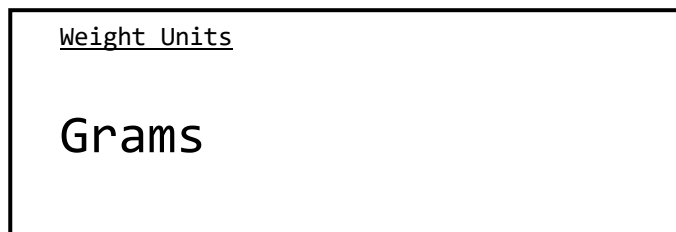

2. Now by pressing the **MENU** or **CAL** button it will be possible to scroll through the weight units forward or backward.
3. Then press the **PRINT** button to confirm the desired weight units.



SYMBOL	UNIT OF MEASUREMENT	CONVERSION FACTOR 1 g =
g	GRAMS	1.
ct	CARATS	5.
oz	OUNCES**	0.035273962
lb	POUNDS**	0.0022046226
Dwt	PENNYWEIGHTS**	0.643014931
ozt	TROY OUNCE**	0.032150747
GN	GRAINS**	15.43235835
tl1	HONG KONG TAEI**	0.02671725
tl2	SYNGAPORE TAEI**	0.02646063
tl3	TAIWAN TAEI**	0.02666666
mo	MOMME**	0.2667

\*\*not available in verified balances

- After having selected the desired weight unit, the screen relative to the menu of balance parameters will be displayed again. It will now be possible to select another parameter or return to weighing mode by pressing the **ON/OFF** button.

By returning to the weighing mode in the right part of the display, the symbol of the selected weight unit will be displayed.

## 9.2 Serial output setup

Different data transmission devices and modes can be selected.

- Select the serial output parameter as described in paragraph 10. The currently set transmission mode will be shown on the display:

Serial output

Continuous

- Now by pressing the **MENU** or **CAL** button it will be possible to scroll through the serial output **MENU** forward or backward.
- Then press the **PRINT** button to confirm the desired transmission mode.

The different transmission modes are illustrated below:

TRANSMISSION MODE	FEATURES
Continuous	Transmits the weight data in a continuous way
On demand	Transmits the weight data only when the <b>PRINT</b> button is pressed
Generic printer	The weight data is printed only when the Busy command is active
Tlp50 printer	The weight data is printed only if the Tlp50 model printer is connected
Upon request - Glp	Transmits the weight data and the Glp information only when the <b>PRINT</b> button is pressed
Generic printer - Glp	The weight data and the Glp information are printed only when the Busy command is active
Tlp – Glp printer	The weight data and the Glp information are printed only if the Tlp50 model printer is connected

**NOTE: transmission speed selection (paragraph 9.3)**

- After having selected the desired transmission mode, the screen relative to the balance parameters menu will be displayed again. It will now be possible to select another parameter or return to weighing mode by pressing the **ON/OFF** button.

### 9.3 Transmission speed selection

Different data transmission speeds can be selected.

- Select the baud rate parameter as described in paragraph 10. The currently set transmission speed will be shown on the display:

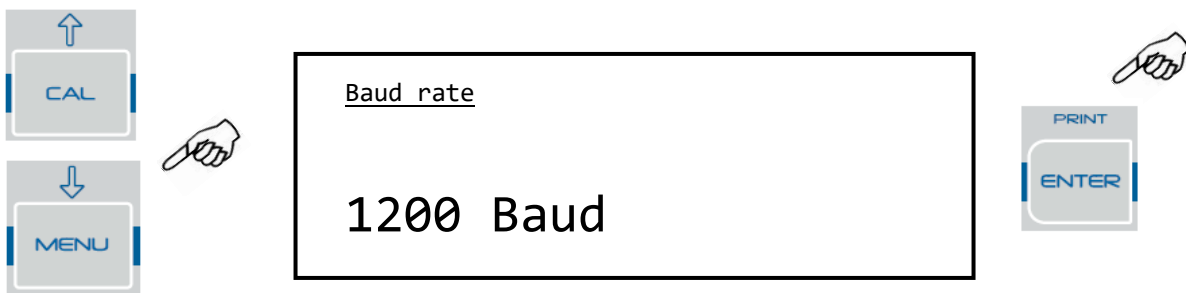

- Select the serial data transmission speed (1200-2400-4800-9600 baud). By pressing the **MENU** or **CAL** button you can scroll the different transmission speeds forward or backward; then confirm the choice with the **PRINT** button.
- After having selected the desired transmission speed, the screen relative to the balance

parameter menu will be displayed again. It will now be possible to select another parameter or return to weighing mode by pressing the **ON/OFF** button.

#### 9.4 Autozero function

Autozero is a correction from a possible deviation from zero.

Different autozero levels can be selected.

1. Select the autozero parameter as described in chapter 10.  
The currently set autozero parameter will be shown on the display:

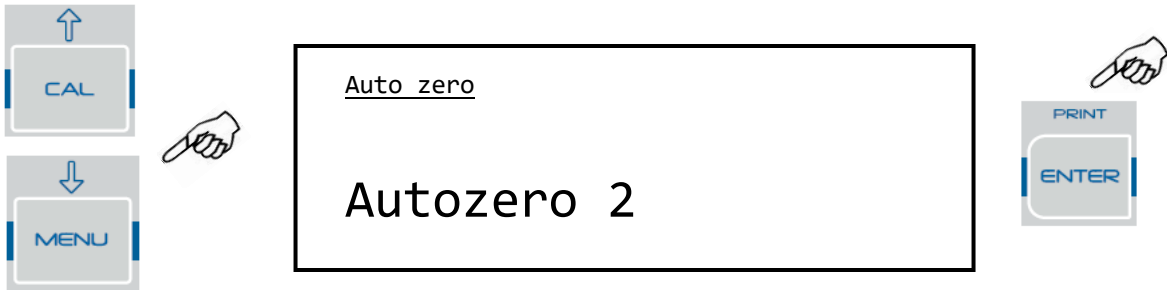

2. Select the desired autozero level. By pressing the **MENU** or **CAL** button it will be possible to scroll through the various levels forward or backward; then confirm your choice with the **PRINT** button.

AUTOZERO MENU	AUTOZERO LEVEL
Autozero off	Autozero off
Autozero 1	Light autozero
Autozero 2*	Average autozero
Autozero 3*	Heavy autozero
Autozero 3E*	Heavy full-scale autozero

\* **locked in verified balances**

3. After having selected the desired autozero, the screen relative to the balance parameters menu will be displayed again. It will now be possible to select another parameter or return to weighing mode by pressing the **ON/OFF** button.

#### 9.5 Filter selection

The balance can be adapted to different environmental conditions thanks to the selection of three different filters:

1. Select the filter parameter as described in paragraph 10.

The currently set filter type will be shown on the display:

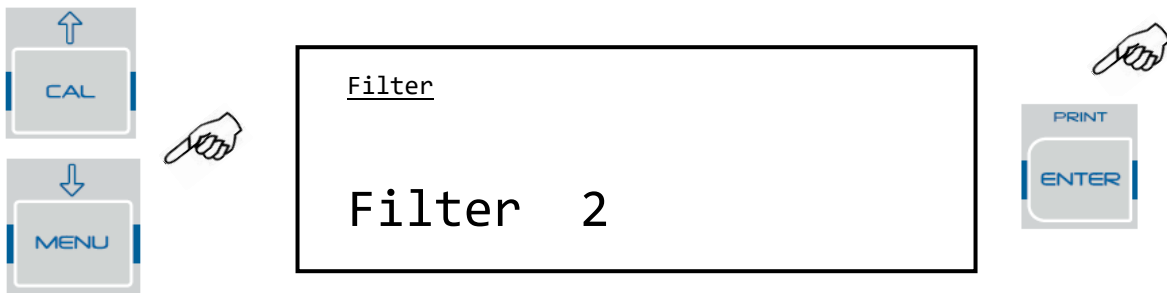

2. Select the desired filter level. Pressing the **MENU** or **CAL** button it will be possible to scroll through the various levels forward or backward; then confirm your choice with the **PRINT** button.

FILTER MENU	FILTER LEVEL
Filter 1	Use this filter level in stable environmental conditions and for use of the instrument in filling or dosing mode
Filter 2	Use this filter level when the environmental conditions are not stable
Filter 3	Use this filter level when the environmental conditions are particularly unstable

3. After having select the desired filter level, the screen relative to the balance parameters menu will be displayed again. It will now be possible to select another parameter or return to weighing mode by pressing the **ON/OFF** button.

## 9.6 Stability function

The stability symbol will appear on the display when the weight is stable within a defined interval.

1. Select the stability parameter as described in paragraph 10.  
The currently set type of stability will be shown on the display:

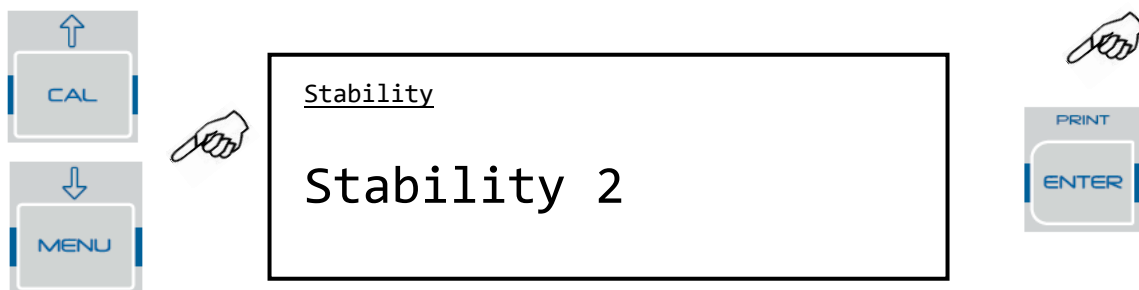

2. Select the desired stability level. By pressing the **MENU** or **CAL** button you can scroll through the various levels forward or backward; then confirm your choice with the **PRINT** button.

STABILITY MENU	LEVEL OF STABILITY
Stability 1	Use this level of stability when the environmental conditions are stable
Stability 2	Use this level of stability when the environmental conditions are less stable
Stability 3	Use this level of stability when the environmental conditions are unstable

3. After having selected the desired level of stability, the screen relative to the balance parameter menu will be displayed again. It will now be possible to select another parameter or return to weighing mode by pressing the **ON/OFF** button.

### 9.7 Contrast Adjustment

The balance's display is equipped with an LCD display; the contrast can be regulated in order to make the indication as visible as possible from different angles.

1. Select the contrast adjustment parameter as described in paragraph 10.  
The currently set contrast value will be shown on the display:

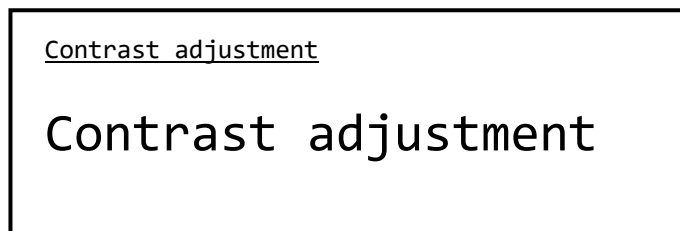

2. Select the desired contrast value. By pressing the **MENU** or **CAL** button it will be possible to increase or decrease the value; then confirm the choice with the **PRINT** button.

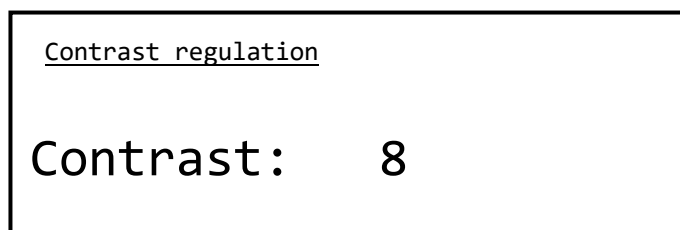

3. After having selected the desired contrast level, the screen relative to the balance parameters menu will be displayed again. It will now be possible to select another parameter or return to weighing mode by pressing the **ON/OFF** button.

## 9.8 Backlight regulation

The balance's display is equipped with a backlight to make the indication visible even in low light conditions.

1. Select the backlight parameter as described in paragraph 10.  
The currently set mode will be shown on the display:

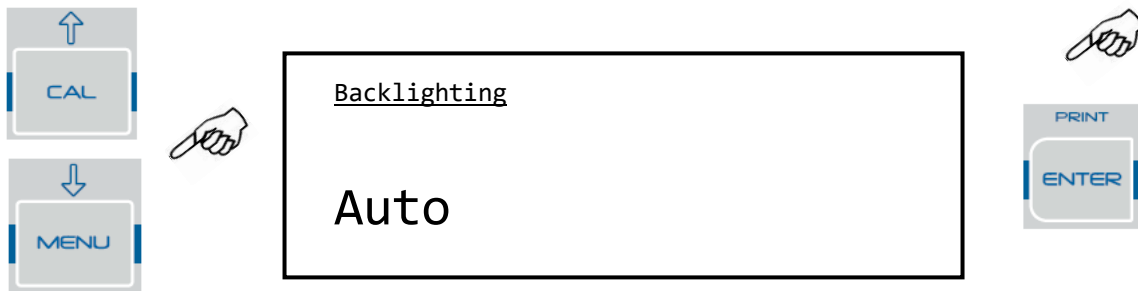

2. Select the desired modality. By pressing the **MENU** or **CAL** button it will be possible to scroll through the various levels forward or backward; then confirm the choice with the **PRINT** button.

BACKLIGHT MENU	BACKLIGHT MODE
Auto	Backlight automatically active during the weighing phases
On	Backlight always on
Off	Backlight always off

3. After having selected the desired mode, the screen relative to the balance parameters menu will be displayed again. It will now be possible to select another parameter or return to weighing mode by pressing the **ON/OFF** button.

## 9.9 Timer-off function

This function allows you to activate the automatic turn-off of the balance after a preset time of inactivity.

1. Select the Timer off parameter as described in paragraph 10.  
The currently set mode will be shown on the display:

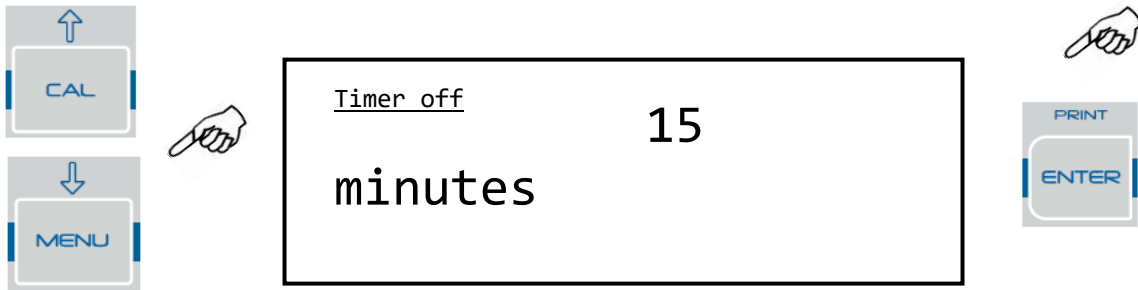

2. Select the desired auto-off modality. By pressing the **MENU** or **CAL** button it will be possible to scroll the various levels forward or backward; then confirm the choice with the **PRINT** button.

TIMER-OFF MENU	AUTO OFF MODE
Disabled	Timer-off disabled
2 minutes	Timer-off after 2 minutes of inactivity
5 minutes	Timer-off after 5 minutes of inactivity
15 minutes	Timer-off after 15 minutes of inactivity

**NOTE:** In balances equipped with an internal battery, it is recommended not to disable the Timer-off mode in order to prolong battery life.

3. After having selected the desired mode, the screen relative to the balance parameters menu will be displayed again. It will now be possible to select another parameter or return to weighing mode by pressing the **ON/OFF** button.

## 9.10 Date and time regulation

This function allows you to regulate the date and time, and to modify the date display format.

1. Select the date and time parameter as described in paragraph 10.

The current set date and time will be shown on the display:

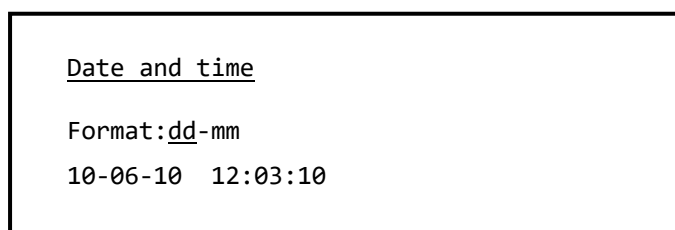

2. Select the desired format of the date. Pressing the **MENU** or **CAL** button it will be possible to modify the format dd-mm or mm-dd; then confirm the choice with the **PRINT** button.

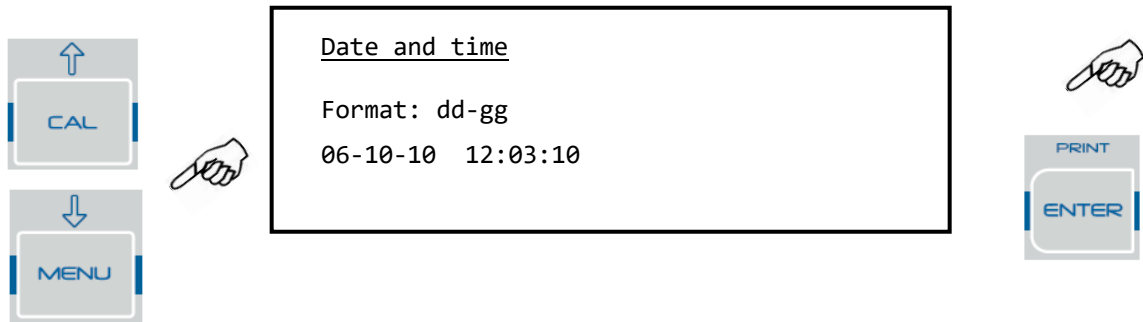

3. Set the desired date and time by using the **MENU** and **CAL** buttons to increase and decrease the number and the **PRINT** button to pass to the next date.

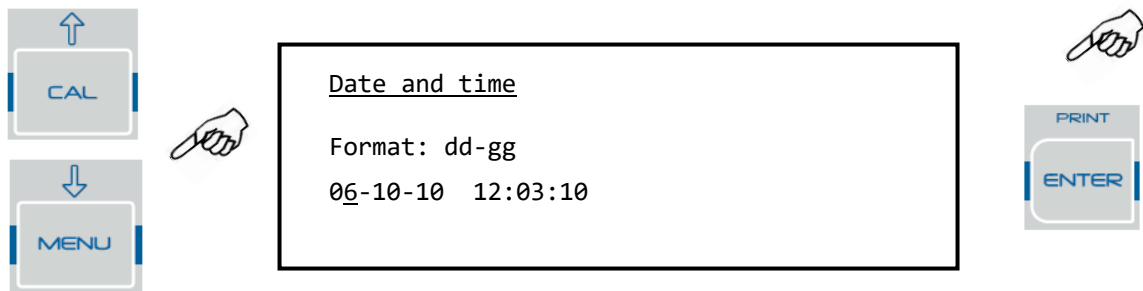

4. After having regulated the date and time, press and hold the **PRINT** button until the beeping stops and then release the button to save the settings.
5. The screen relative to the balance parameters menu will then be displayed. It will now be possible to select another parameter or return to weighing mode by pressing the **ON/OFF** button.



## 9.11 Language selection

This function allows you to set the desired usage language.

1. Select the language parameter as described in paragraph 10.  
The currently set language will be shown on the display:

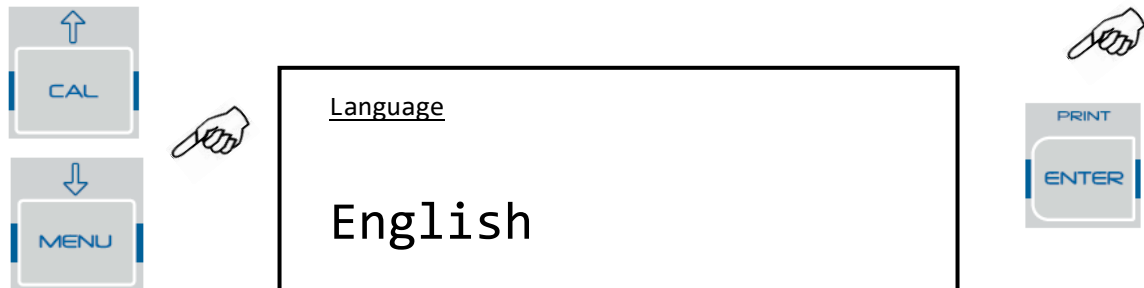

2. Select the desired language. By pressing the **MENU** or **CAL** button it will be possible to scroll the various levels forward or backward; then confirm your choice with the **PRINT** button.

LANGUAGE MENU	LANGUAGE
Italian	Italian language
English	English language
Português	Portuguese language
Deutsch	German language
Français	French language
Español	Spanish language

- After having selected the desired language, the screen relative to the balance parameters menu will be displayed again. It will now be possible to select another parameter or return to weighing mode by pressing the **ON/OFF** button.

## 9.12 Calibration mode setting

This function allows you to set the calibration mode.

\* This function is only available for the models equipped with internal calibration (not available for all models). To check if the instrument is equipped with internal calibration mode, refer to the table of technical features, chapter 18.

1. Select the calibration mode parameter as described in paragraph 10.  
The currently set calibration mode will be shown on the display:

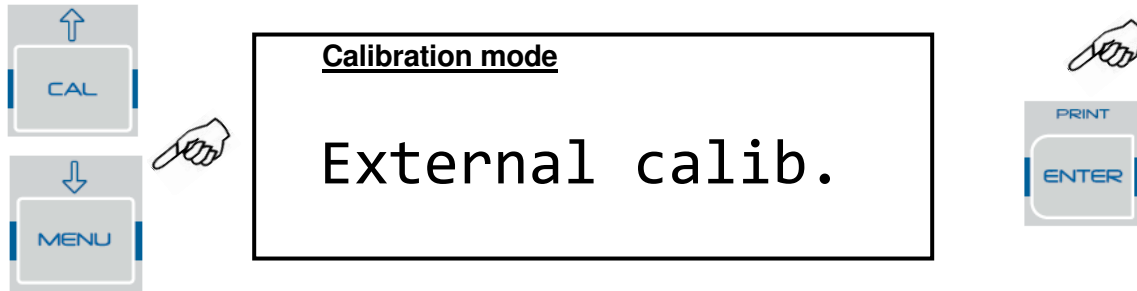

2. Select the desired mode. By pressing the **MENU** or **CAL** buttons it will be possible to scroll the different calibration modes forward or backward:
  - External calibration\*
  - Internal calibration\*
  - Automatic calibration
  - Technical calibration\***\*Locked for verified balances models**
3. Press the **PRINT** button to confirm “**AUT-CAL**”, “**I-CAL**”, “**E-CAL**”.  
To confirm “**TEC-CAL**”, keep the **PRINT** button pressed until the beeping stops.
4. The screen relative to the balance parameters menu will then be displayed. It will now be possible to select another parameter or return to weighing mode by pressing the **ON/OFF** button.

### 9.12.1 Automatic Calibration (AUT-CAL)



**This is Factory setting for verified balances models**

The balance self-calibrates when the temperature variation exceeds the factory preset value and at factory preset time intervals, through the internal reference mass, and only if the balance pan is empty.

When the balance needs to perform the Automatic calibration, the display will show the following message:

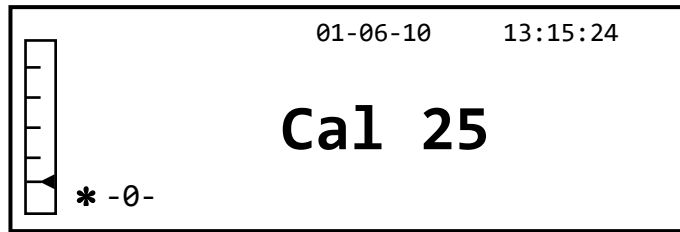

A 25-second countdown will start during which you can decide if:

- Stop the automatic-calibration procedure by pressing the “**ON/OFF**” button that will be delayed of 5 minutes
- or
- Let the countdown finish so that the automatic calibration starts

**Note: during the countdown do NOT load anything on the weigh pan!**

In this mode, it is also possible to carry out the calibration with the internal reference mass by pressing the **CAL** button at any moment, first ensuring that no weight is loaded on the plate.

1. Press the **CAL** button with the plate empty. The display will show the message “**CAL**” and the balance’s calibration will be carried out automatically.

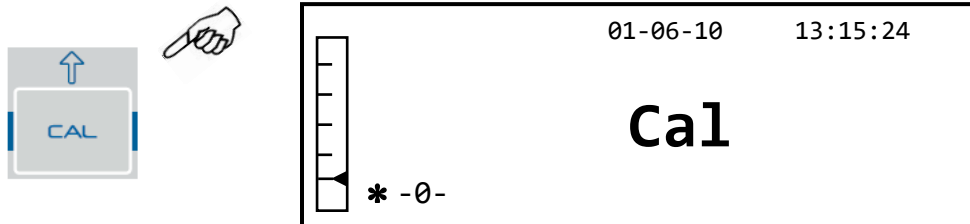

2. At the end of the calibration, the balance will return to normal weighing conditions.

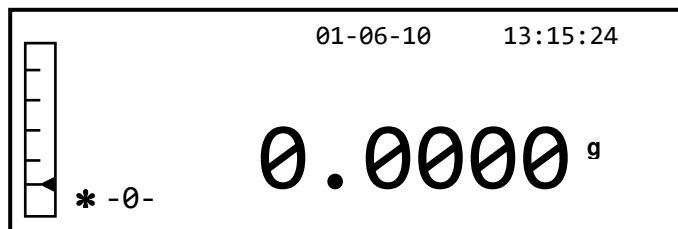

If the calibration is not completed due to vibrations or drafts, the message “**CAL bUt**” will be displayed. Press the **CAL bUt** button again, and if the problem persists, select external calibration and contact the supplier.

### 9.12.2 Internal calibration (I-CAL) [locked for verified balances]

The balance calibrates itself through the internal reference mass **ONLY** upon the request of the

user by pressing the **CAL** button.

Before carrying out the internal calibration, ensure that no weight is loaded on the plate.

### 9.12.3 External calibration (E-CAL) [locked for verified balances]

The balance will be calibrated by using the external reference mass.  
(Follow the procedures described in paragraph 8.1.2)

### 9.12.4 Technical calibration (TEC-CAL) [locked for verified balances]

This function allows the internal reference mass to be calibrated whenever assistance-control-maintenance interventions make this necessary.

1. After having selected the **TEC-CAL** calibration mode, press the **CAL** button with the plate empty. The word “CAL” will be displayed.

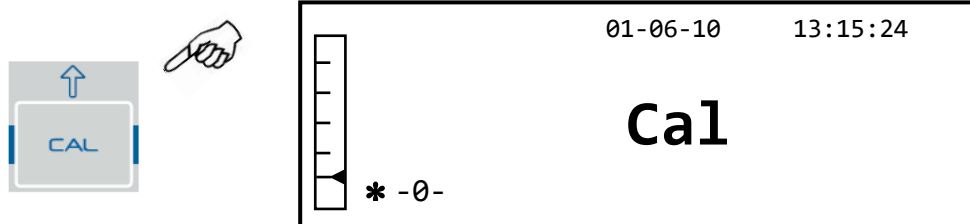

2. When the value of the calibration weight begins to flash, load the calibration weight on the plate.

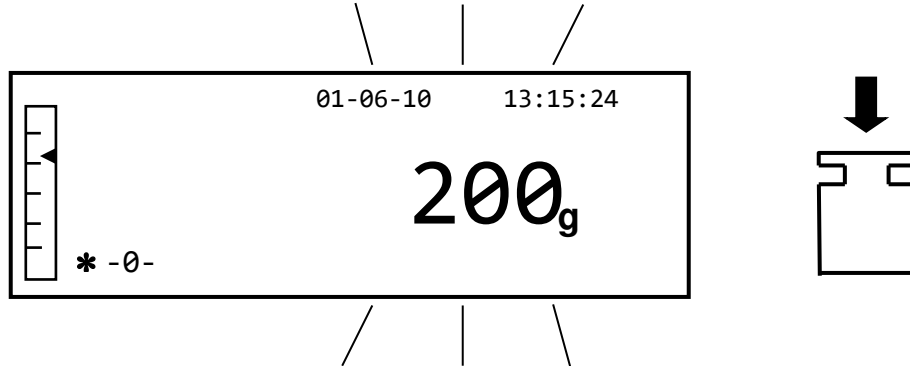

3. Wait for the calibrated weight to be displayed and the stability symbol to turn on, and then remove the weight from the plate.
4. When “**0.000**” is shown on the display, press the **PRINT** button in a prolonged manner until the beeping stops. The acquisition and automatic storage of the internal weight will now begin. During the acquisition cycle, the display will show the following flashing writing:

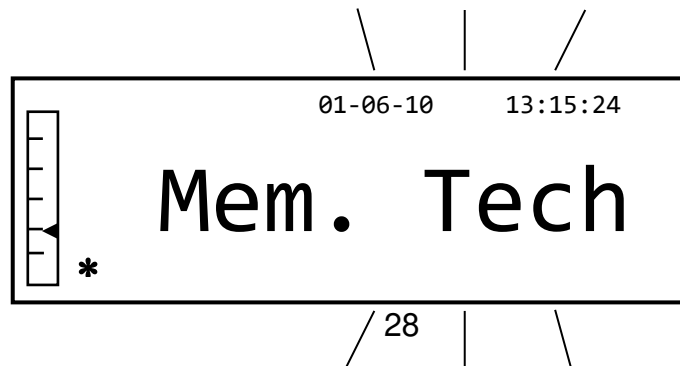

5. Once the internal calibration has been stored, the balance will return to the normal weighing condition.
6. Now re-enter the calibration menu as described in paragraph 9.1.12 and set the desired internal, automatic, or external calibration modality.



**WARNING: this procedure must be carried out only using class E2 or equivalent reference masses.**

### 9.13 Calibration data

This function allows you to display the data relative to the last calibration carried out.

- Date
  - Calibration mode
  - Correction
1. Select the calibration data parameter as described in paragraph 10.  
The data relative to the last calibration carried out will be shown on the display:

Calibration data	
10-06-10	
External calib.	2000.0g
Corr.:	1.2g

2. Press the **PRINT** button to print the calibration data.
3. Press the **ON/OFF** button to exit from the screen and return to the balance parameters menu.  
It will now be possible to select another parameter or return to weighing mode by pressing the **ON/OFF** button.

## 10 Balance programs menu

1. Press the **MENU** button with the plate empty.
2. The following writing will be shown on the display:

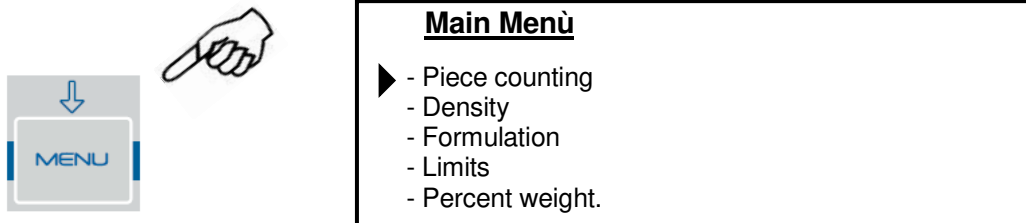

3. Now use the CAL and MENU buttons to navigate forward or backward in the menu of parameters.

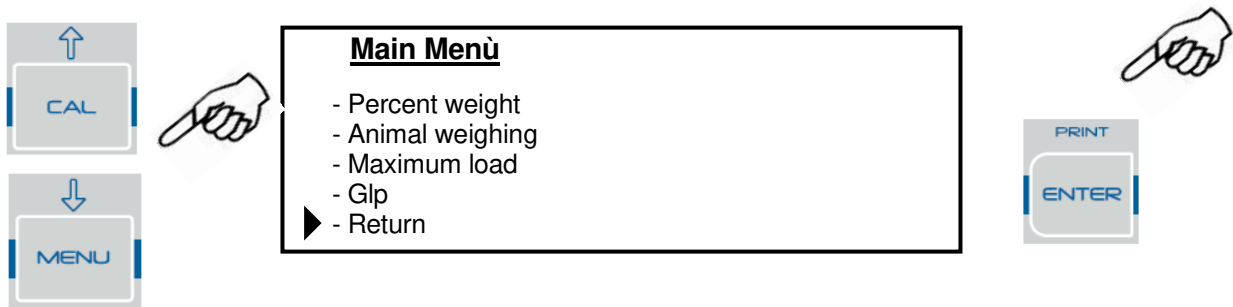

4. Position the cursor on the desired parameter and press the PRINT button to confirm the selection.
5. Press the ON/OFF button to exit from the menu or select the return function and press the PRINT button.

### 10.1 Piece counting function

The piece counting program allows you to carry out a total count of the pieces after having carried out a sampling of pieces or having inserted the average unit weight of the piece.

1. Select the piece counting program as described in paragraph 10.  
The following screen will be shown on the display:

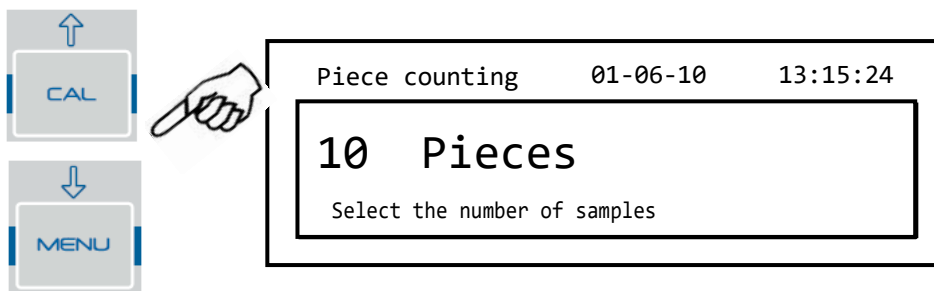

1. Select the number of pieces to put on the plate as a sample, pressing in sequence the **MENU** button to increase and the **CAL** button to decrease.
2. Load an empty container, if used, then press the **PRINT** button to confirm.  
The choice of the number of pieces (10, 25, 50, 100, manual, see chapter 10.3) is a function of the weight of an individual piece. Load the empty container, if used.

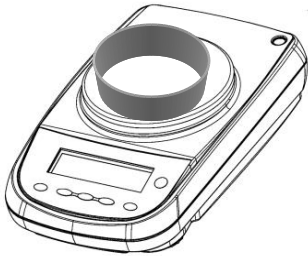

3. Load the number of pieces indicated on the display on the plate and press the **PRINT** button.

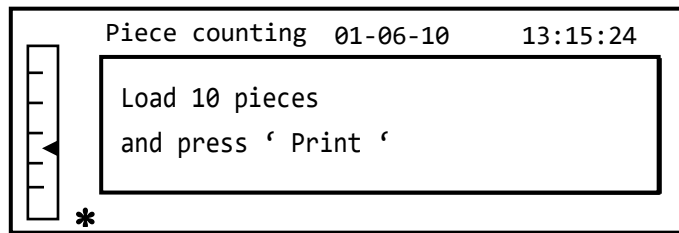

If there are enough samples (e.g. 10 as in the figure), the number of pieces loaded will appear on the display. It will now be possible to proceed with the counting of the pieces.

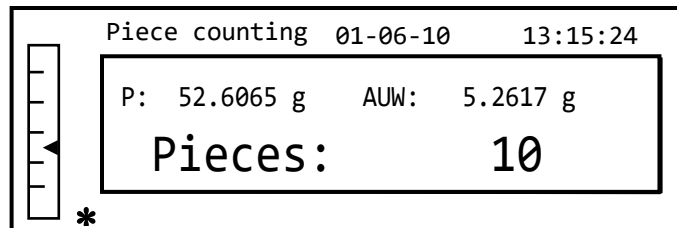

If the pieces to be counted have a weight that is too little with respect to the balance's resolution, an error message will be displayed.

In this case it will be necessary to turn to a balance with greater resolution.

If the weight of the samples is acceptable but not sufficient, the following message will be displayed: Add enough pieces so as to approximately double the quantity loaded on the plate, then press the **PRINT** button.

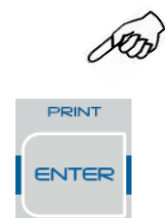
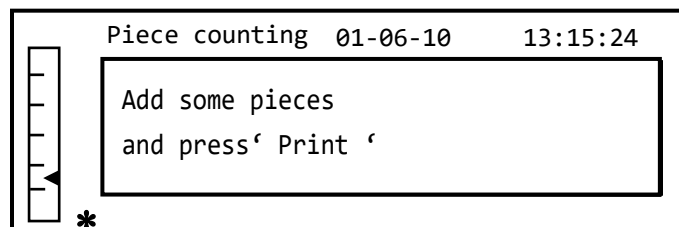
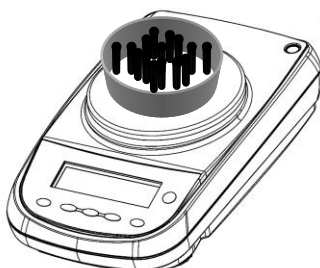

If the number of pieces is still insufficient, the message indicated above will be displayed again. Double the quantity of pieces loaded again.

Once a sufficient number of pieces has been reached, their number will be displayed and it will be possible to proceed with the counting, loading the pieces to be counted on the plate.

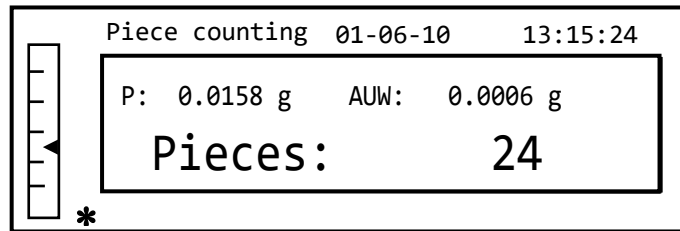

4. To exit from piece counting mode, press the **ON/OFF** button and the balance will return to the normal weighing conditions.

### 10.1.1 Manual insertion of the average unit weight

This function allows the user to enter, when known, the average unit weight of the piece, thus avoiding the sampling of the pieces.

1. Select the piece counting program as described in paragraph 10. The following screen will be shown on the display:

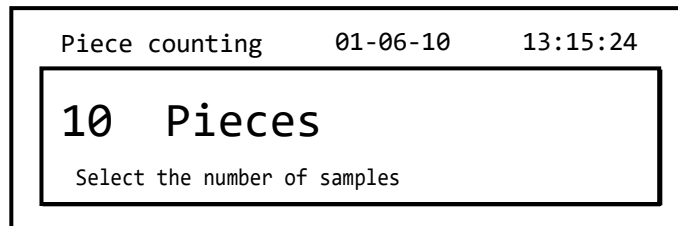

2. Press the **MENU** button until the following message appears on the display:

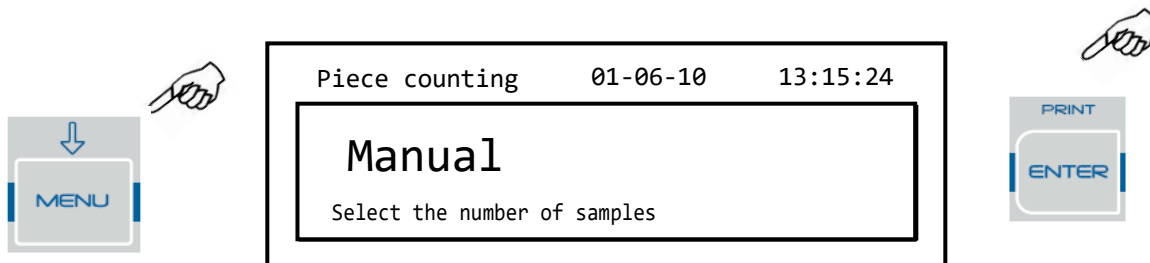

3. Then press the **PRINT** button to confirm.

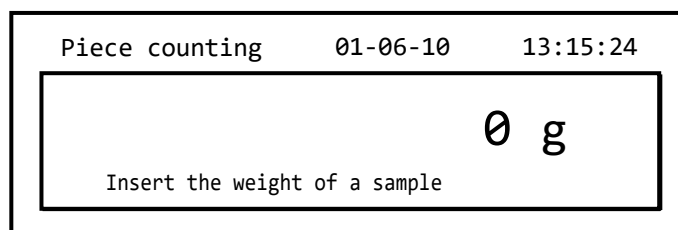



4. Insert the piece's unit weight in grams using the **CAL** and **MENU** buttons to increase and decrease the value, while pressing the **TARE** button to pass to the next value. To insert a decimal point, hold down the **CAL** button for a prolonged time. During the entering phase, the prolonged pressing of the **TARE** button allows you to delete the inserted value.

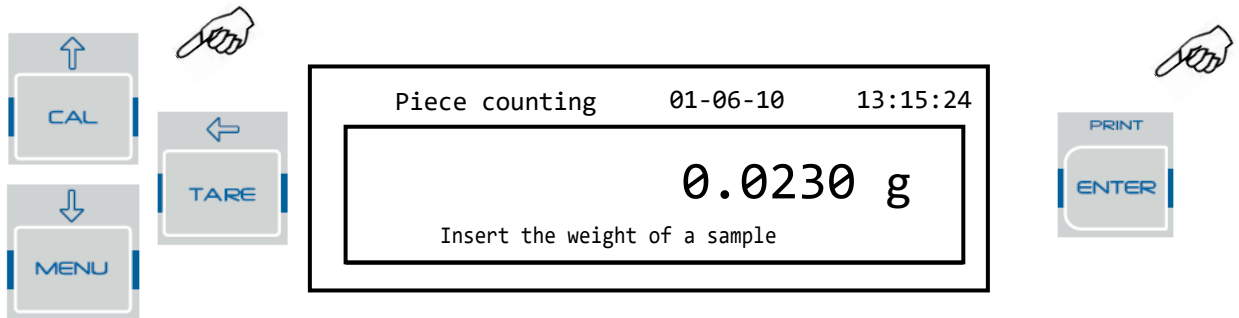

5. Press the **PRINT** button to confirm.  
If the piece entered is less than 100 times the resolution of the balance, an error message will be displayed.  
To exit without entering the weight, press the **ON/OFF** button.
6. If the weight is sufficient, "0" will be shown on the display; it is now possible to proceed with the counting, loading the pieces on the plate.

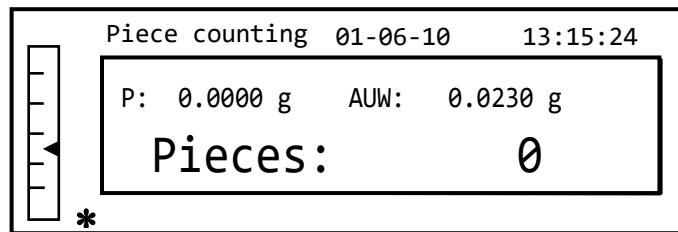

7. To exit from the piece counting function, press the **ON/OFF** button.

It is also possible to use the optional alphanumeric keyboard to insert the average unit weight of the sample. In this case, carry out the same procedure described above to enter manual insertion mode.

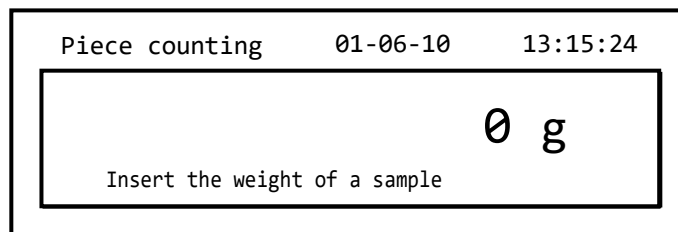

1. Insert the unit weight in grams of the sample by using the numeric keys from 0 to 9 and the decimal point.  
In case of error, press the **CLEAR** button and restart.

2. Press the **INSER** button to confirm.
3. If the piece entered is less than 100 times the resolution of the balance, an error message will be displayed.  
To exit without entering the weight, press **ESCAPE** (on the alphanumeric keyboard) or **ON/OFF**.
4. If the weight is sufficient, “0” will be shown on the display; it is now possible to proceed with the counting, loading the pieces on the plate.
5. To exit from the piece counting function, press the **ON/OFF** button.

### 10.1.2 Automatic updating of the average unit weight

After having carried out the sampling, the average unit weight can be updated in the following way.

1. Instead of loading all of the pieces to be counted, load a number of pieces approximately double that of those loaded on the plate and wait for the beep.
2. This procedure can now be repeated up to a maximum of 255 pieces or you can proceed with the normal counting of the pieces.  
This mechanism allows for a more accurate estimate of the average unit weight and a better precision in the counting of the pieces.

**NOTE: the automatic updating mechanism is not active if the sampling has been carried out through insertion of the average unit weight.**

## 10.2 Program for the determination of the density of a solid or a liquid

The density calculation program allows the determination of the density of a solid or liquid through the use of the lower weighing hook or the hydrostatic kit (optional Code T027).

### 10.2.1 Solid density determination

1. Select the density program as described in paragraph 10.  
The following screen will be shown on the display:

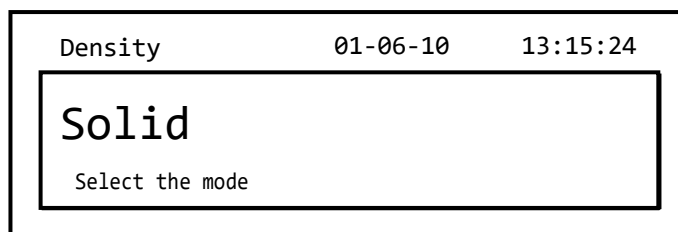

2. Then press the **PRINT** button to confirm the selection.

- The density value of the liquid to be used will be displayed. The default value is equal to 1.0000 (distilled water at 20°C).

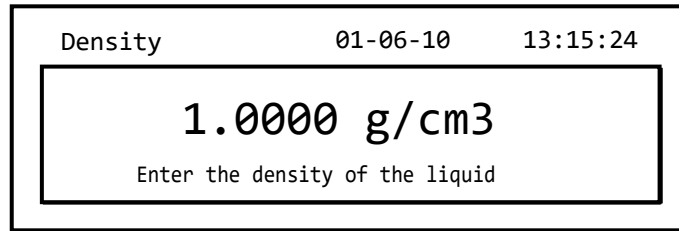

- It is possible to insert a different value using the **CAL** and **MENU** buttons to increase and decrease the value, while pressing the **TARE** button to pass to the next value. During the entering phase, prolonged pressure on the **TARE** button allows you to cancel the inserted value.

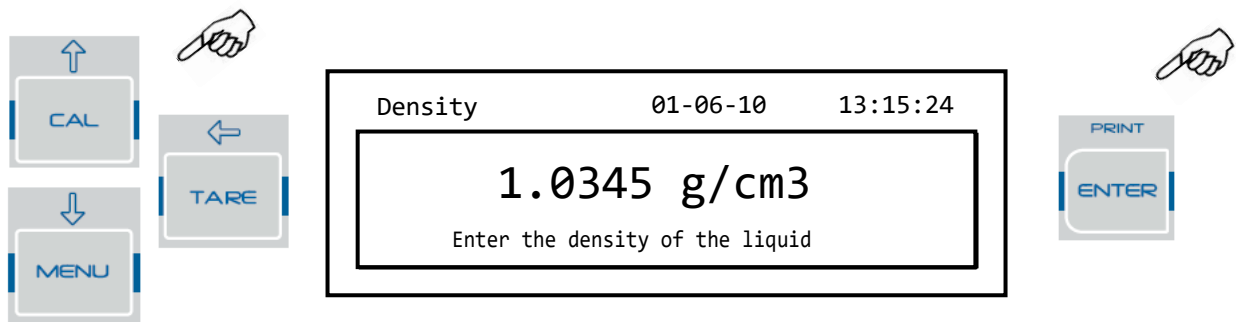

**Note:** It is also possible to set the value using the optional alphanumeric keypad.

- Once the desired value has been set, press the **PRINT** button.
- It will now ask you to weigh the solid in the air.

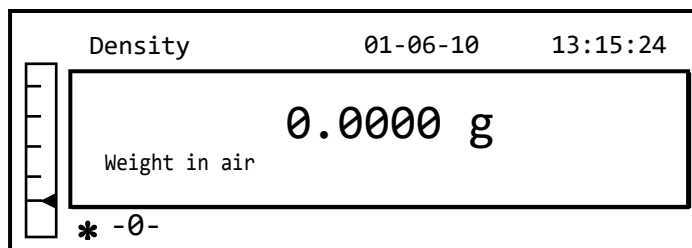

- Carry out a tare if necessary and load the solid. Wait for the stability symbol to appear and press the **PRINT** button to acquire the value. The word 'wait...' will appear during the acquisition of the value.
- The weight of the solid in the liquid will then be requested. Carry out the tare of the drum in the liquid. Put the solid in the drum, immerse the solid, and wait for the stability indicator to appear. Then press the **PRINT** button. The word 'wait...' will be displayed during the acquisition of the value.

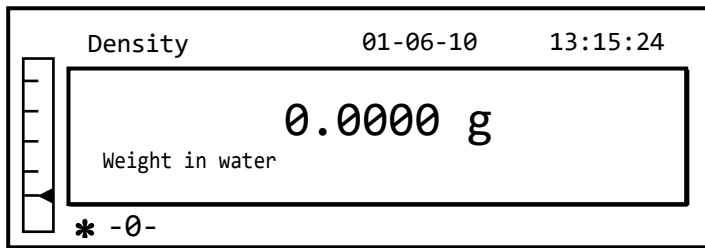

9. The result of the density calculation of the solid will now be displayed. If the balance is equipped with a printer, it will be possible to print the density value by pressing the **PRINT** button.

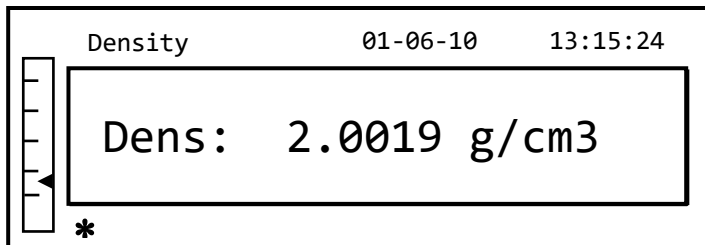

10. The following string will be shown on the display in case of error:

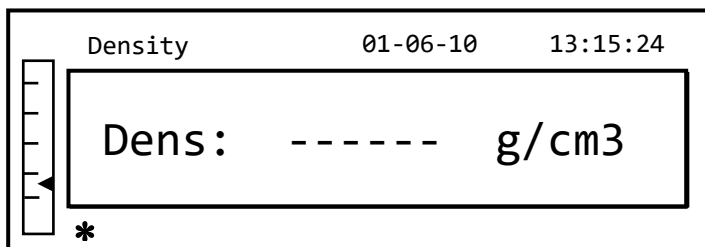

11. Now press the **ON/OFF** button to exit from the density function, or the **MENU** button to carry out the density measurement for another solid.

### 10.2.2 Liquid density determination

1. Select the density program as described in paragraph 10. The following screen will be shown on the display:

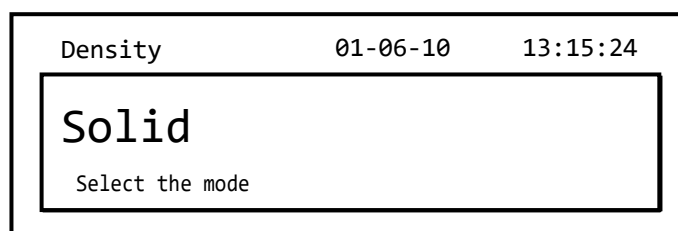

2. Press the **MENU** button select liquid mode. Then press the **PRINT** button to confirm.

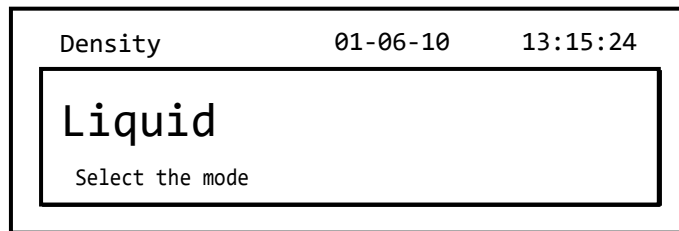

- The default value of the solid's density will be displayed. The default value is equal to 3.0000 g/cm<sup>3</sup>.

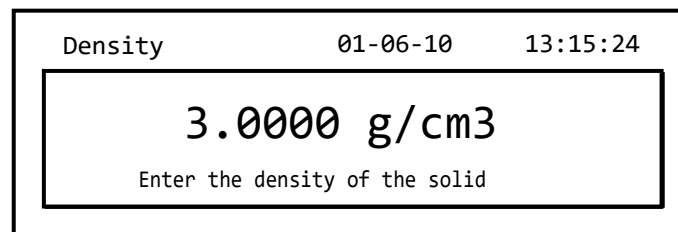

- A different value can be entered by using the **CAL** and **MENU** buttons to increase and decrease the value, while pressing the **TARE** button to pass to the next value. During the entering phase, prolonged pressure on the **TARE** button allows you to delete the inserted value.

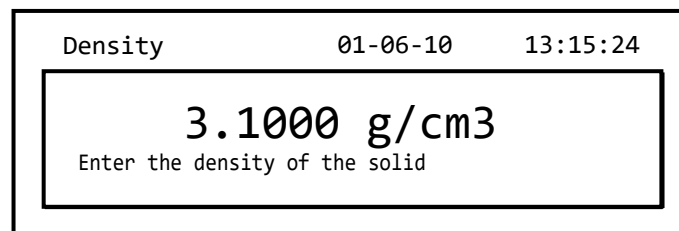
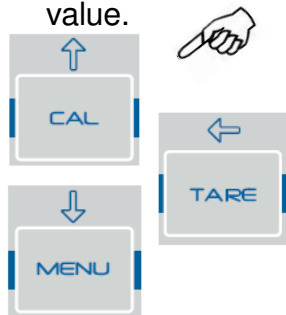

**Note:** It is also possible to set the value using the optional alphanumeric keypad.

- Once the desired value has been set, press the **PRINT** button.
- It will now ask you to weigh the dipstick in the air.

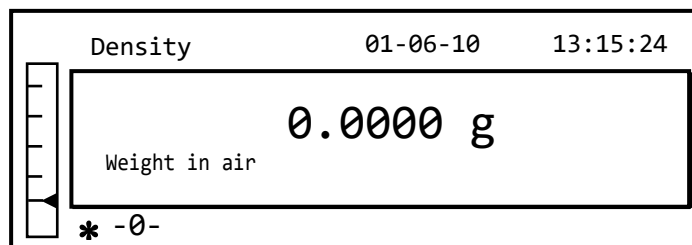

- Carry out a tare if necessary and load the dipstick. Wait for the stability symbol to appear and press the **PRINT** button to acquire the value. The word 'wait...' will appear during the acquisition of the value.

8. The weighing of the dipstick immersed in the liquid will then be requested. Then immerse the solid in the liquid, wait for the stability indicator to appear, and then press the **PRINT** button. The word ‘wait...’ will be displayed during the acquisition of the value.

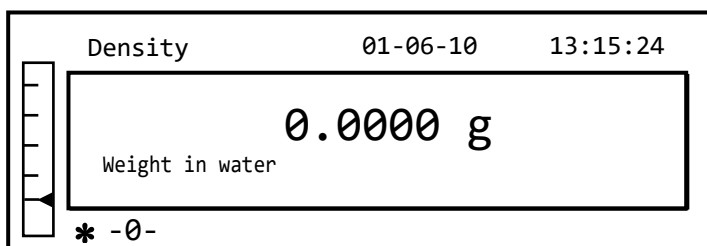

9. The result of the density calculation of the liquid will now be displayed. If the balance is equipped with a printer, it will be possible to print the density value by pressing the **PRINT** button.

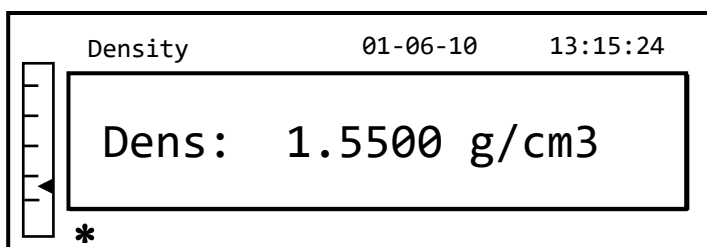

10. The following string will be shown on the display in case of error:

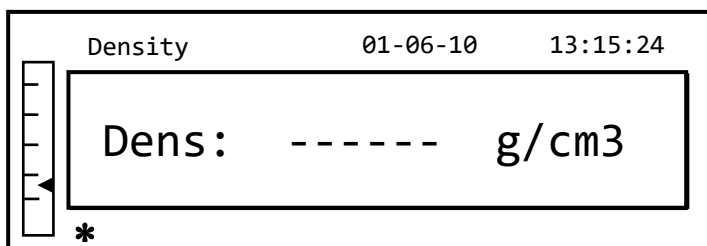

11. Now press the **ON/OFF** button to exit from the density function, or the **MENU** button to carry out the density measurement for another liquid.

## 10.3 Formulation function

### 10.3.1 Manual formulation

1. Select the formulation program as described in paragraph 10.  
The following screen will be shown on the display:

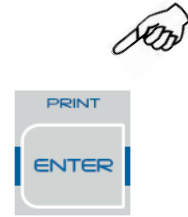
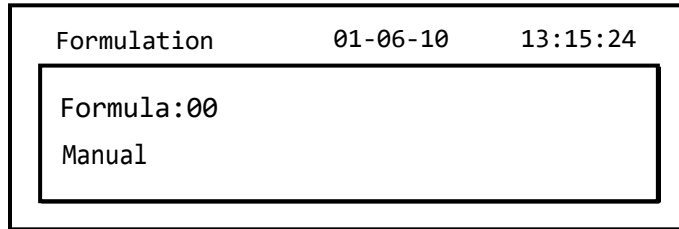

2. Then press the PRINT button to confirm the selection.

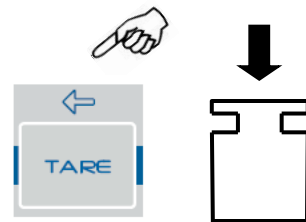
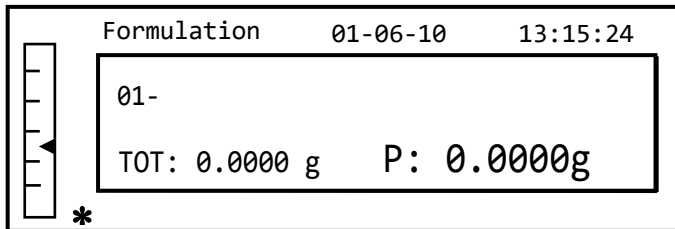

3. Carry out a tare operation if necessary, and load the first ingredient.

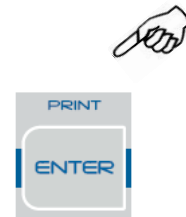
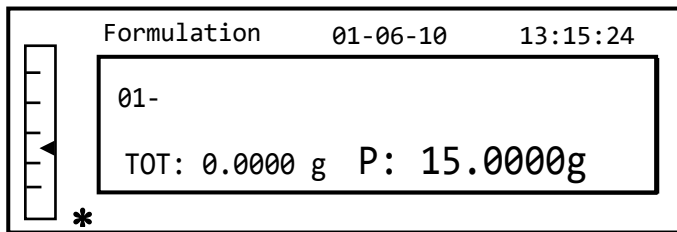

4. Then press the **PRINT** button to confirm.

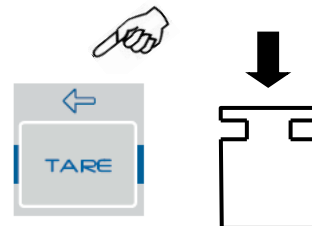
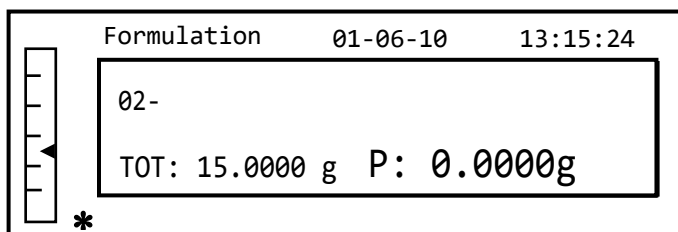

5. Carry out a tare operation if necessary, and load the second ingredient.

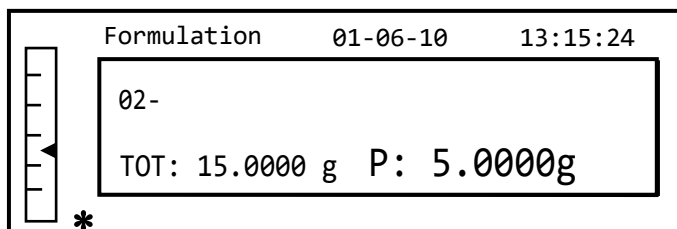

6. Then press the **PRINT** button to confirm.
7. Repeat the operation for a maximum number of 99 ingredients.

**Note:** During the acquisition of the ingredient, the display of Err10 indicates a negative weight value. Check not to have made a mistake with the ingredient loading and zeroing procedure.

8. To end, print the value of the individual components and the total value, and press and keep pressed the **PRINT** button until the beeping stops. The display will show the following screen:

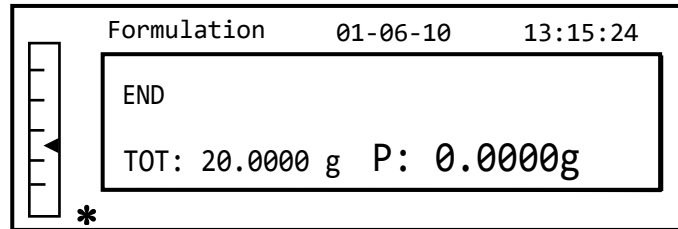

9. To exit from the screen and carry out a new formulation, press the **ON/OFF** button once. To exit from the program and return to the weighing screen, press the **ON/OFF** button two consecutive times.

### 10.3.2 Formula saving

1. Select the formulation program as described in paragraph 10. The following screen will be shown on the display:

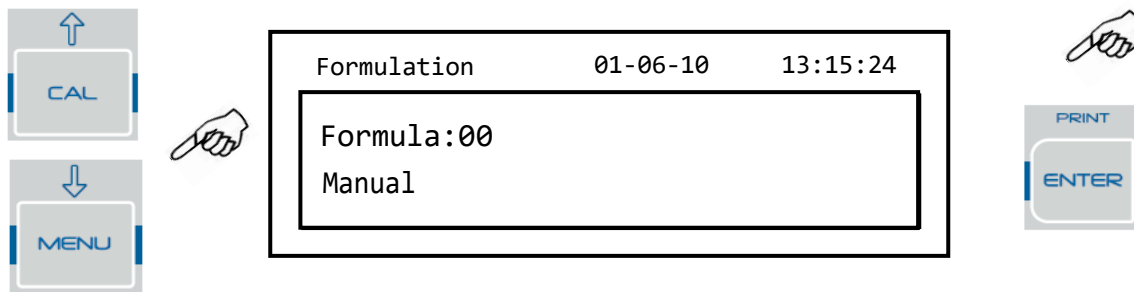

2. Select the number of the formula to save or modify using the **CAL** and **MENU** buttons to increase and decrease the value, after the word 'Formula'. Then press and keep pressed the **PRINT** button until the beeping stops to confirm the selection and enter the 'setup formula' menu.

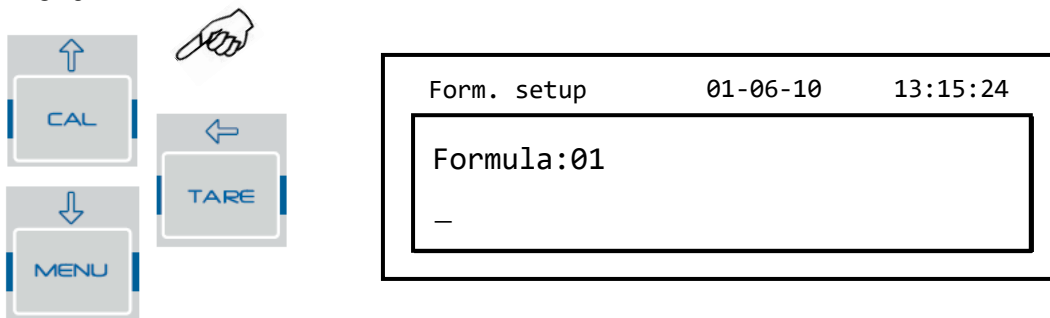



3. Enter the name of the formula (it can be a series of numbers or letters, max 20 characters) using the **MENU** or **CAL** buttons to scroll all of the available characters, and the **TARE** button to pass to the next character. To select the uppercase or lowercase character, press and hold the **MENU** button until the beeping stops.

**Note:** It is also possible to set the value using the optional alphanumeric keypad.

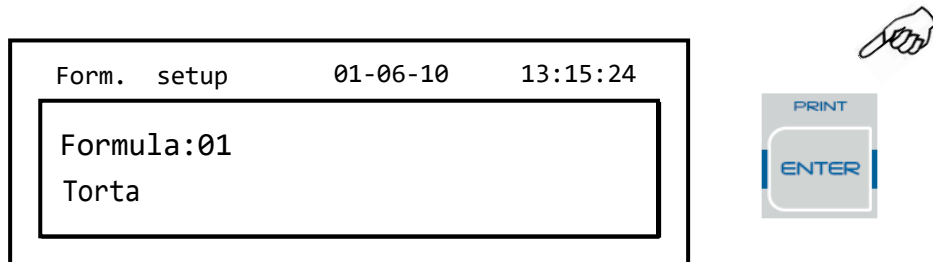

4. Press the **PRINT** button to confirm.

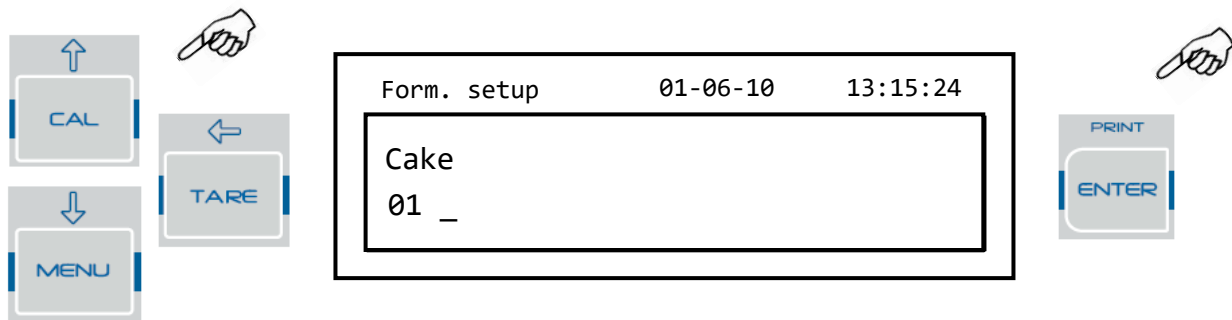

5. Enter the name of the first component (it can be a series of numbers or letters, max 11 characters) using the **MENU** or **CAL** buttons to scroll through the available characters.

6. Then press the **PRINT** button to confirm and save the value.

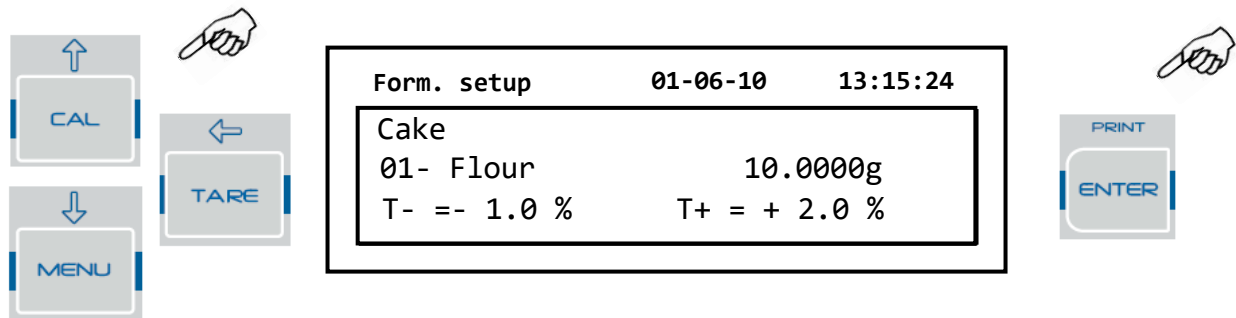

7. Now enter the quantity of the component using the **MENU** or **CAL** buttons to increase or decrease the value while pressing the **TARE** button to pass to the next value and the **PRINT** button to pass to the next parameter
8. Now enter the negative tolerance and press **PRINT** button to pass next parameter
9. Now enter the positive tolerance.

10. Then press the **PRINT** button to confirm and save the value.
11. Repeat the operation described from point 5 to point 10 to enter all of the desired components up to a maximum of 20.
12. After having entered all of the desired components press the **ON/OFF** button to exit from the formula saving procedure.

### 10.3.3 Formula recall

1. Select the formulation program as described in paragraph 10.  
The following screen will be shown on the display:

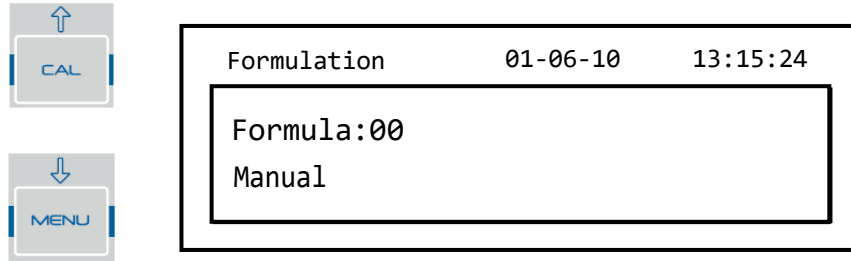

2. Choose the name of the formula (previously saved) using the **CAL** and **MENU** keys to scroll through the various formulas inserted.

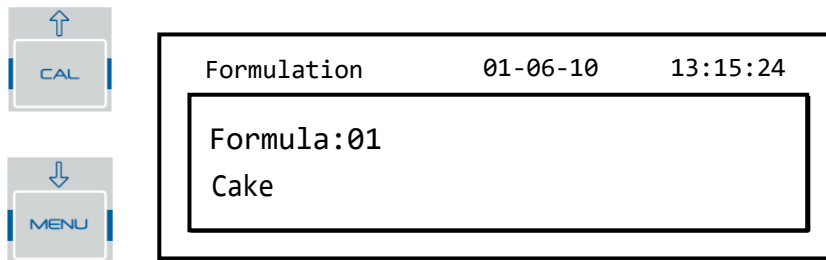

3. Then press the **PRINT** button to confirm the selection.

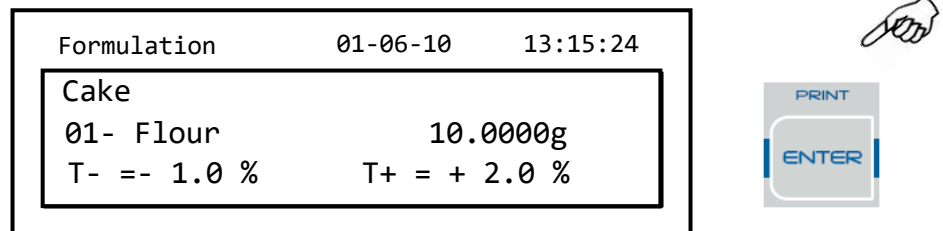

4. It will now be possible to display the various components and the relative quantities of the selected formula using the **MENU** and **CAL** buttons.

- Press the **PRINT** button again to insert the constant multiplier.

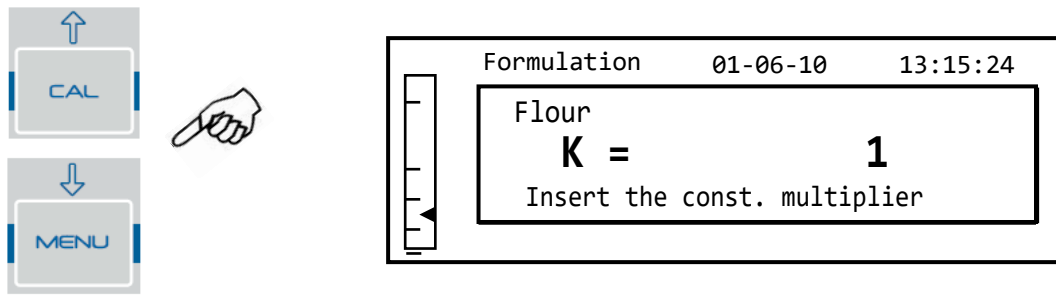

- Insert now the multiplicative constant K to determine the desired amount of product. Use the **MENU** or **CAL** buttons to increase or decrease the value.

**Example:** if the entered formula is for 100g of product, inserting  $K = 2$  the values of all components will be recalculated to obtain a total amount of product equal to 200g.

- Press the **PRINT** button again to begin weighing the various components. If necessary, carry out the tare operation before measuring out the quantity of component indicated at the top right of the display

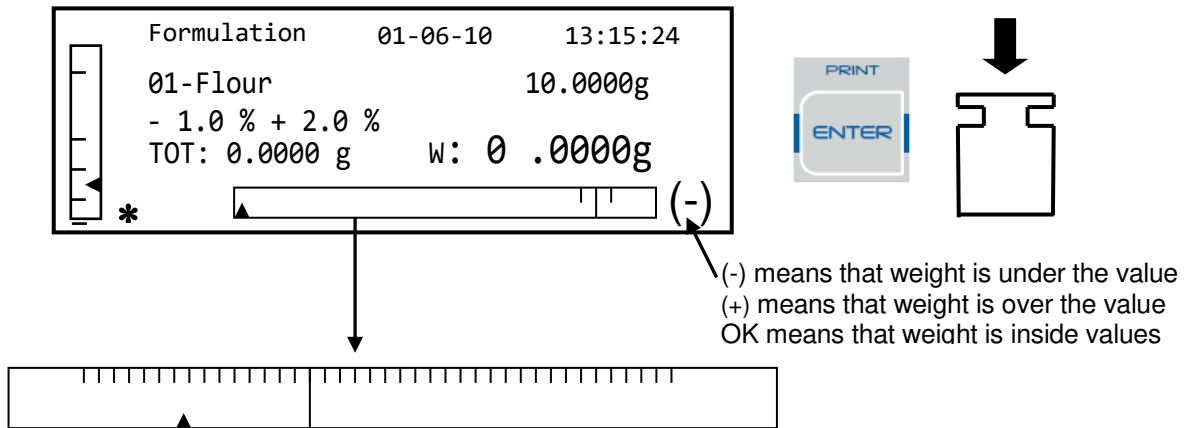

To facilitate the dosing operation, when the value of the component is approaching the threshold of the acceptable value, the dosing bar will automatically zoom.

- Then press the **PRINT** button to pass to the next component.

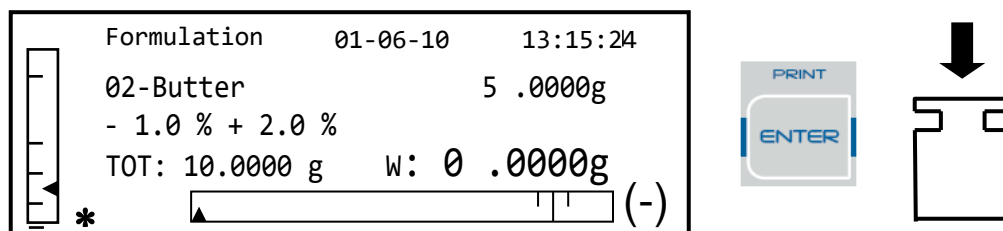

- If necessary, carry out the tare operation before measuring out the quantity of component indicated at the top right of the display.

- Then press the **PRINT** button to pass to the next component.

11. Repeat the procedure until the last component, after which the weights of the single components measured and the total weight will be printed if the instrument is equipped with a printer. The display will show the following screen:

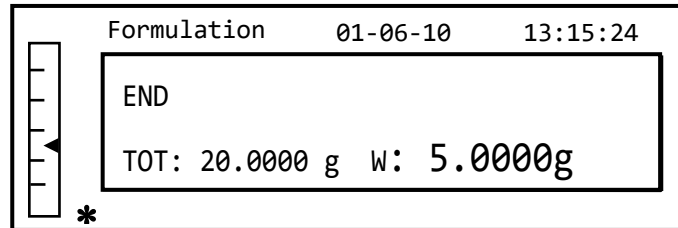

12. To exit from the screen and carry out a new formulation, press the **ON/OFF** button once. To exit from the program and return to the weighing screen, press the **ON/OFF** button two consecutive times.

To interrupt and exit from the formulation function at any time, press the ON/OFF button.

## 10.4 Max-Min thresholds function.

The thresholds function allows you to determine if the weight loaded on the plate is above or below two thresholds pre-set by the user.

1. Select the thresholds function as described in paragraph 10.  
The following screen will be shown on the display:

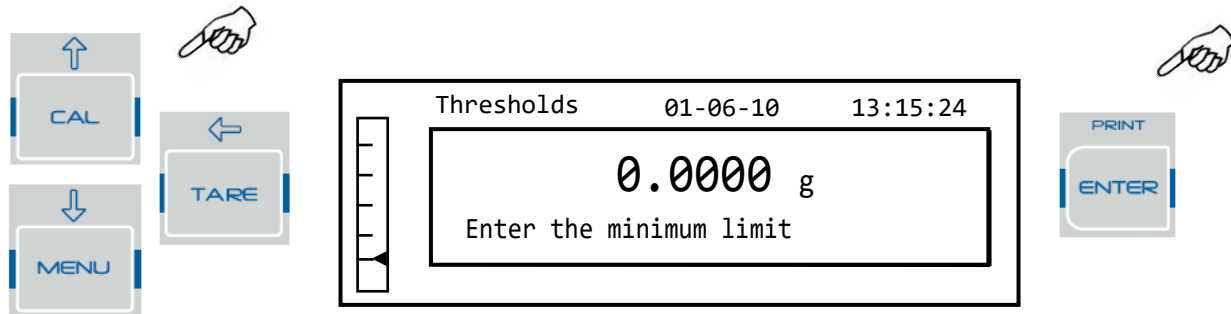

2. Enter the MINIMUM limit value by using the **CAL** and **MENU** buttons to increase and decrease the value, while pressing the **TARE** button to pass to the next number. During the entering phase, prolonged pressure on the **TARE** button allows you to delete the entered value.
3. Then press the **PRINT** button to confirm. The entered value will remain in memory until the balance is turned off.
4. The following screen will then be displayed.

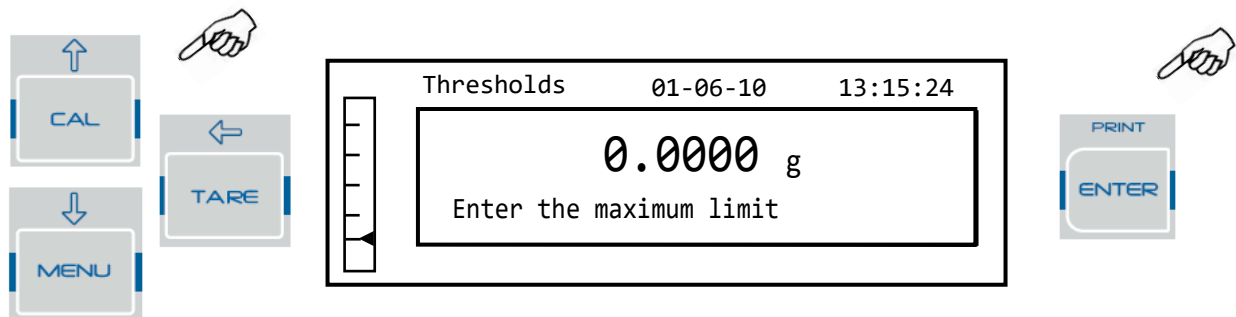

5. Now insert the MAXIMUM limit using the same procedure described for the insertion of the MINIMUM limit.
6. Then press the **PRINT** button to confirm. The entered value will remain in memory until the balance is turned off.

**Note:** It is also possible to set the value by using the optional alphanumeric keypad.

7. The following screen will then be displayed.

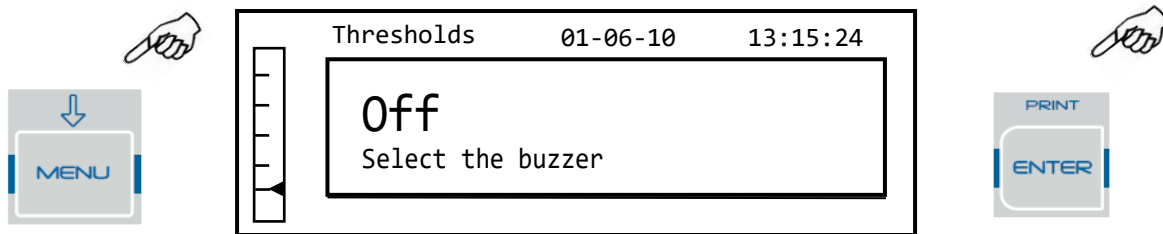

8. Through the **MENU** key, select the activation or not of the acoustic signal when the weight is within the two set limits. Then confirm the selection by pressing the **ENTER** button.
9. If the thresholds have been inserted correctly, the balance will return to weighing mode with an indication of the threshold status (+ MAX threshold, - MIN threshold, **OK** within the two limits sets).

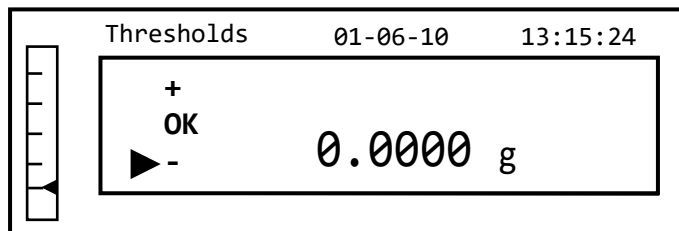

**NOTE: If the values have not been set correctly, the word ERROR 07 will be displayed.**

The thresholds function has three operating modes.

#### 10.4.1 With both the limits set

This mode allows to identify an acceptance range, inserting a lower limit and an upper limit, in which the value of weight is considered ok, identified by the "OK" symbol that is visualized on the display together with the acoustic signal, if activated. When the weight is under the value of the lower limit set, the symbol "L" is visualized on display, while if the value is over the upper limit set, the symbol "H" is visualized on display.

#### 10.4.2 With only the lower limit set

When only the lower limit is set and the upper limit is left to zero, the weight is considered ok each time the value of weight is over the lower limit set, identified by the "OK" symbol that is visualized on the display together with the acoustic signal, if activated. When the weight is under the value of the lower limit set, the symbol "L" is visualized on display.

#### 10.4.3 With only the upper limit set

When only the upper limit is set and the lower limit is left to zero, the weight is considered ok each time the value of weight is under the upper limit set, identified by the "OK" symbol that is visualized on the display together with the acoustic signal, if activated. When the weight is over the value of the upper limit set, the symbol "H" is visualized on display.

## 10.5 Percentage weighing function

This function allows you to read the weight as a percentage of a reference weight. The reference weight is assumed as the 100% value (factory setting).

There are two modes for the acquisition of the reference weight – an automatic one (with reference weight), and a manual one (with the manual entry of the value of the reference weight).

### 10.5.1 Automatic mode with reference weight

1. Select the percentage weighing function as described in paragraph 10.  
The following screen will be shown on the display:

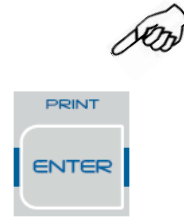
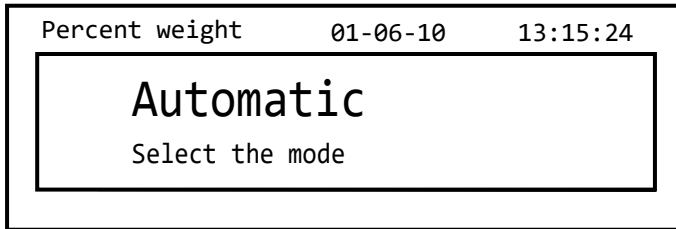

2. Confirm automatic mode by pressing the **PRINT** button.
3. The tare will be carried out and you will be asked to load the reference weight on the plate.

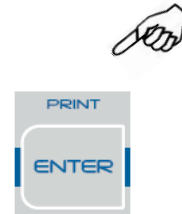
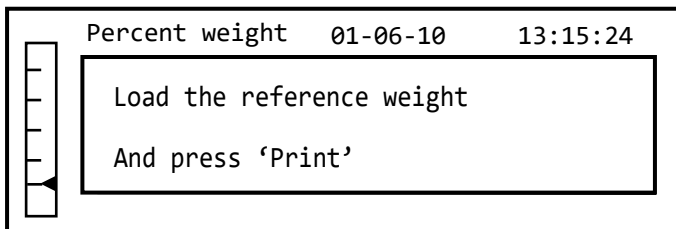

4. Load the reference weight on the plate and then press the **PRINT** button; the word "Wait" will be shown. Once the weight is acquired, a screen with an indication of the weight loaded, reference weight, and percentage weight will be shown.

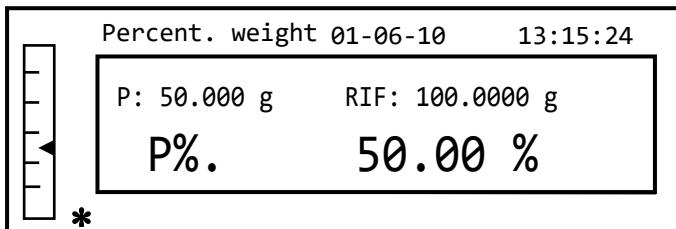

5. Now remove the reference weight, load the sample and read the percentage weight.
6. Press the **ON/OFF** button to exit from the percentage weighing function.

**NOTE:** If the reference weight entered is less than 10 displayed digits, the word **ERROR 07** will be shown.

## 10.5.2 Mode with manual insertion of the reference weight.

1. Select the percentage weight function as described in paragraph 10.  
The following screen will be shown on the display:

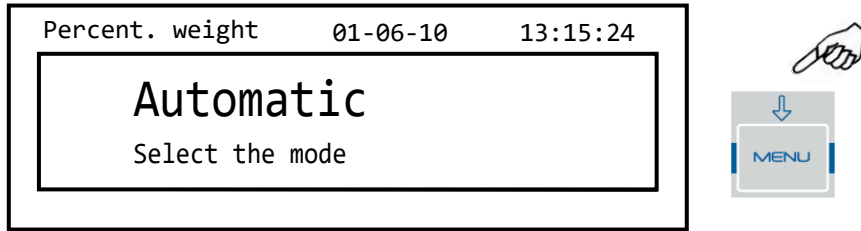

2. Press the **MENU** button to select manual mode

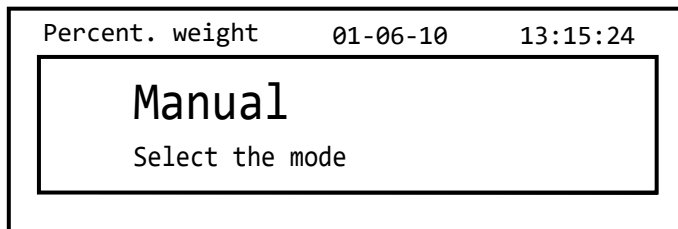

3. Confirm manual mode by pressing the **PRINT** button.

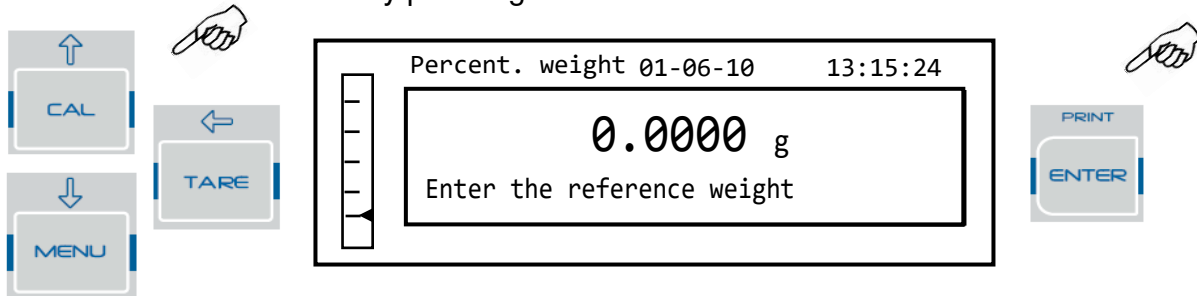

4. You can now enter the reference weight value, using the **CAL** and **MENU** keys to increase and decrease the value, while pressing the **TARE** button to pass to the next value. During the entry phase, holding down the **TARE** button allows you to delete the value entered. The value entered will remain in the memory until the balance is turned off. It is also possible to enter the value using the optional alphanumeric keypad.
5. After having inserted the desired reference weight value, press the **ENTER** key.

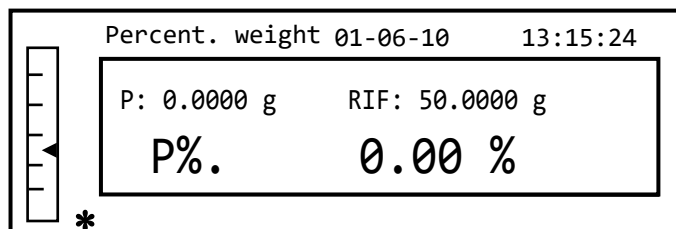

6. Now load the sample and read the percentage value.
7. Press the **ON/OFF** button to exit from the percentage weighing function.

**NOTE:** If the reference weight entered is less than 10 displayed digits, the word **ERROR 07** will be shown.



## 10.6 Animal weighing function

Thus function allows you to acquire an averaged weight of moving objects or animals for a settable period of time.

1. Select the animal weighing function as described in paragraph 10.  
The following screen will be shown on the display:

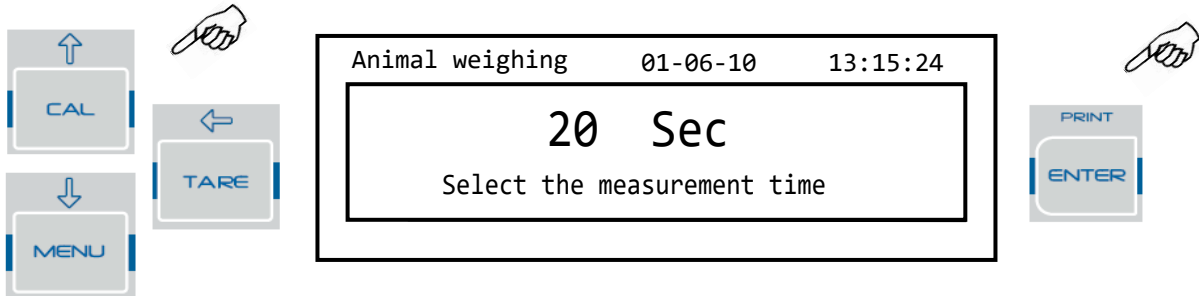

2. Set the desired time from 5 to 90 seconds using the **MENU** key to decrease and **CAL** to increase. Then confirm by pressing the **PRINT** button.

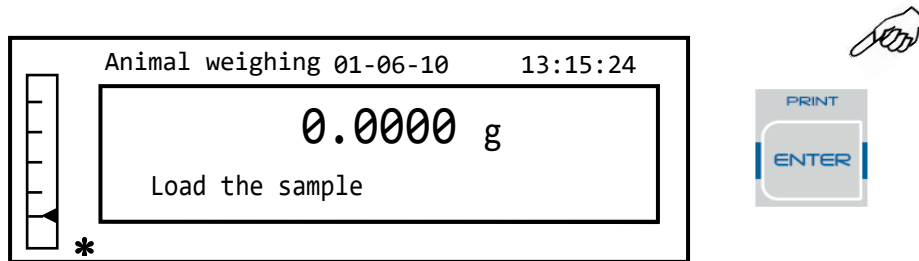

3. Load the sample to be weighed on the plate and press the **PRINT** button; the value of the current weight and the set sampling countdown time will be displayed.

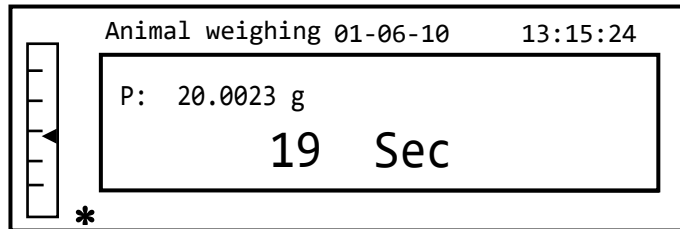

4. Once acquired, the weight will be shown on the display with an indication of the average weight detected.

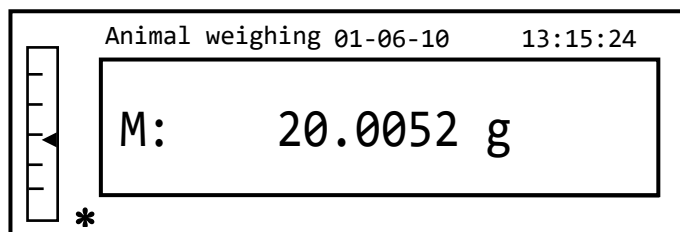

5. Press the **ON/OFF** button once to carry out another measurement, or twice to exit from the function.

## 10.7 Maximum load function

The “maximum load” function allows you to measure the maximum breakage load of a solid.

1. Select the maximum load function as described in paragraph 10.  
A tare will automatically be carried out and the following screen will be shown on the display with an indication of the maximum load function at the top left:

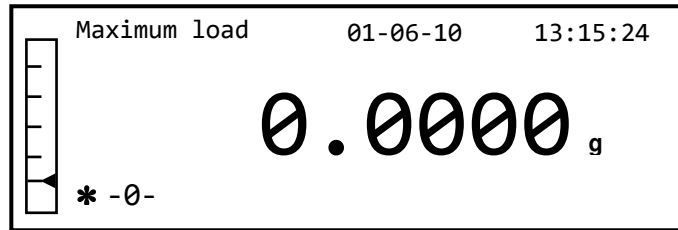

2. The breakage weight can now be detected.

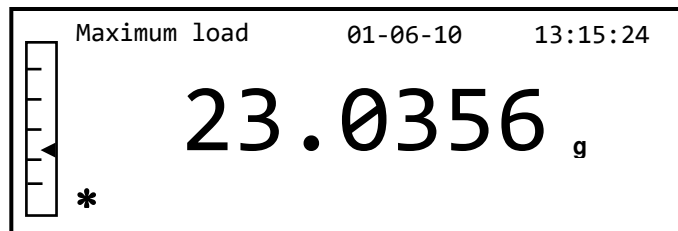

3. Press the **TARE** button to carry out another measurement.
4. Press the **ON/OFF** button to exit from the maximum load function.

## 10.8 GLP function (Good Laboratory Practices)

The “GLP” function allows you to save the identifying parameters of the instrument and operator to be able to print them along with the value of the test results.

1. Select the GLP function as described in paragraph 10.  
The following screen will be shown:

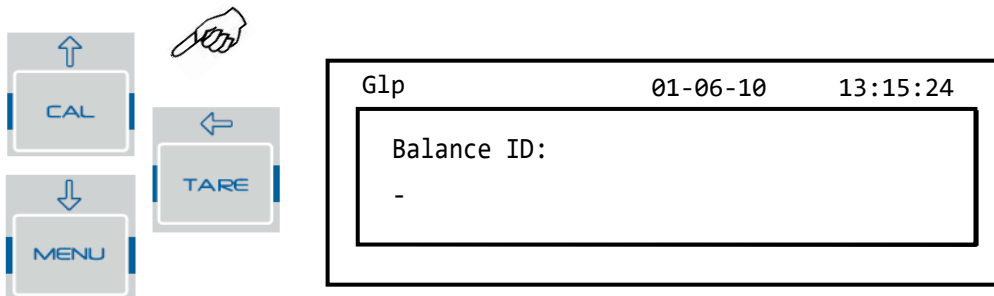

2. Enter the balance ID (it can be a series of numbers or letters, max 18 characters) using the **MENU** and **CAL** buttons to scroll through all of the available characters. To select uppercase or lowercase characters, press and hold the **MENU** button until the beeping stops.

**Note: It is also possible to set the value by using the optional alphanumeric keypad.**

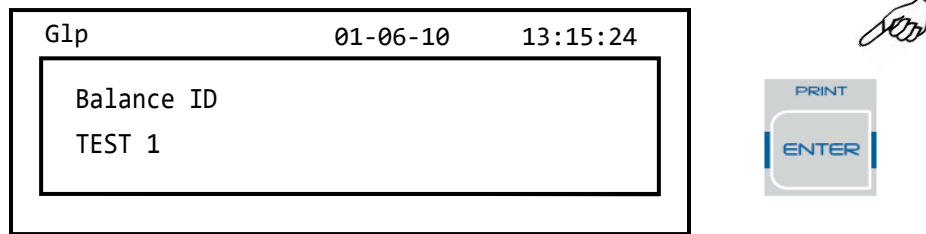

3. Enter the user ID (it can be a series of numbers or letters, max 18 characters) using the **MENU** and **CAL** buttons to scroll through all of the available characters.

**Note: It is also possible to set the value by using the optional alphanumeric keypad.**

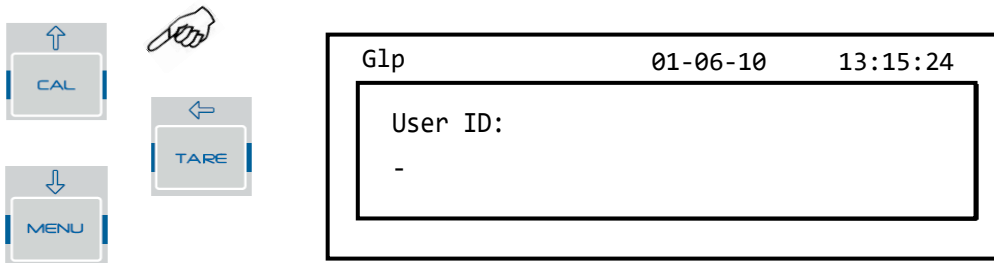

4. Confirm by pressing the **PRINT** button.

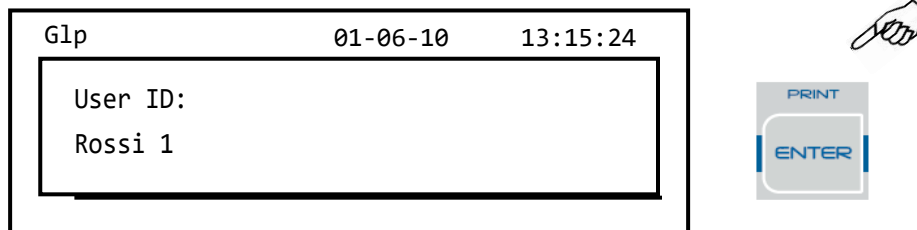

5. Enter the project identifier (it can be a series of numbers or letters, max 18 characters) using the **MENU** and **CAL** buttons to scroll through all of the available characters.

**Note: It is also possible to set the value by using the optional alphanumeric keypad.**

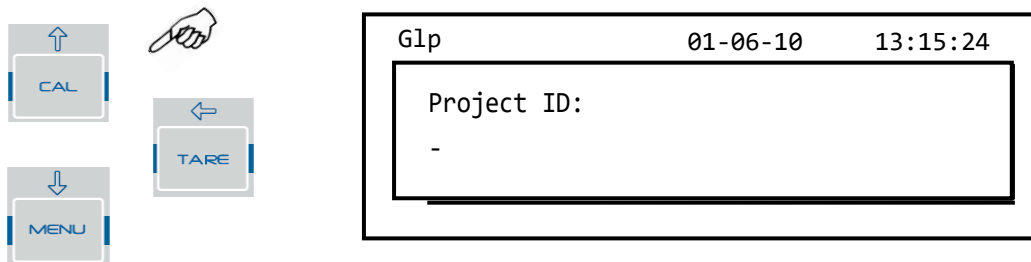

6. Then confirm all of the data entered by pressing and holding the **PRINT** button until the beeping stops.

Glp	01-06-10	13:15:24
Project ID: Testing		



2 Sec

7. The balance will automatically return to the weighing screen.

## 11 RS232 Interface features

### 11.1 General features

The balance transmits the value visualized on the display following serial RS232C standard, allowing to print the value of weight to a PC monitor or to a serial printer. In the case of connection to a PC, it will be possible to select the transmission in continuous mode or transmission at user command through pressing of the PRINT button ( as described at par.9.2). The balance is also capable of receiving commands, always through the standard RS232C, that allow performing all the functions available through the keyboard of PC itself. The speed of transmission and reception can be selected, as described previously (see par.9.3), to 1200, 2400, 4800, e 9600 baud. The character format is of 8 bit preceded by one bit of start and followed by a bit of stop. Parity is not considered.

### 11.2 Map of connector

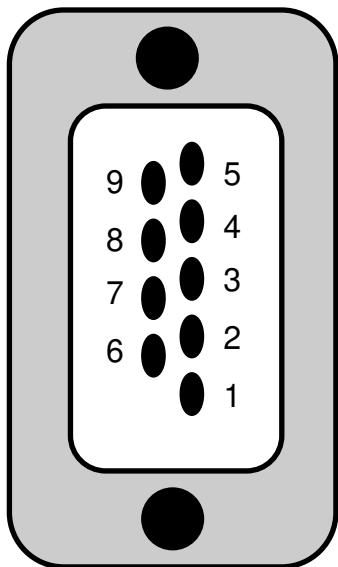

#### CONNECTOR MAP CONNECTION FOR KEYPAD, PC AND PRINTER

- pin 1 = Power +5v for keyboard
- pin 2 = signal Tx
- pin 3 = signal Rx
- pin 4 = busy signal
- pin 5 = Gnd
- pin 4-6 = connected eachother for transmission to PC

### 11.3 Connecton of the balance to the optional alphanumeric keyboard

To connect the optional external alphanumeric keyboard to the balance, it must be used the same connector that is used to link the balance to PC. In this case the connection to PC or to printer must be effected through the connector placed on the optional alphanumeric keyboard.

### 11.4 Connection of the Balance to computer

To receive/transmit data, link the connector (n.2 of fig.1 at par.5) of the balance to the serial port of your Personal Computer as shown below:

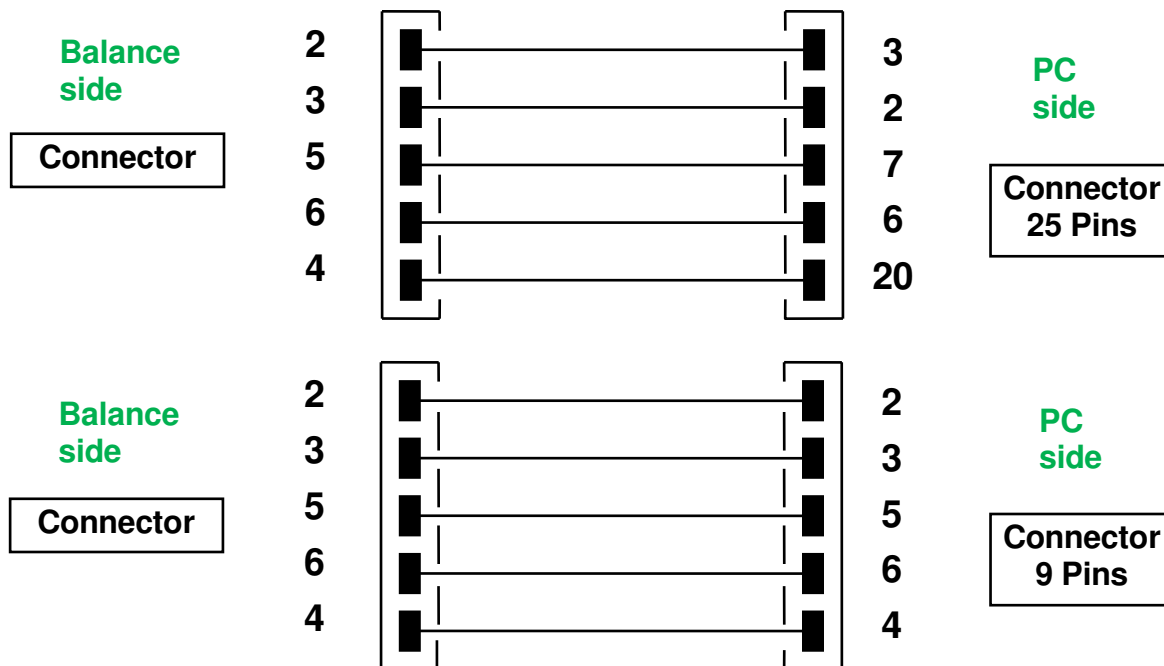

There are three ways of transmission in which the Balance and the computer can be interfaced:

- Continuous transmission of weight data (continuous mode must be set from the menu as explained in the paragraph 9.2).
- On demand transmission of weight data (on demand mode must be set from the menu as explained in the paragraph 9.2).
- On demand transmission with GLP of weight data (on demand mode with GLP must be set from the menu as explained in the paragraph 9.2).

In all the modes it is possible to execute all the balance's functions directly from the computer's keyboard, transmitting to balance the ASCII codes as shown in the table below.

CODE	1 <sup>st</sup> FUNCTION (SINGLE PRESS)
"T" = H54	TARE
"C" = H43	CALIBRATION
"E" = H45	ENTER
"M" = H4D	MENU
"O" = H4F	ON/OFF

CODICE	2 <sup>nd</sup> FUNCTION (PROLONGED PRESS)
"t" = H74	TARE
"c" = H63	CALIBRATION
"e" = H65	ENTER
"m" = H6D	MENU
"o" = H6F	ON/OFF

### 11.4.1 Continuous Transmission mode

**String transmitted is composed by the following 14 characters:**

- First character: weight sign (blank or -)
- Second to ninth character: weight or other data
- Tenth to twelfth character: weight unit symbol
- thirteenth character: stability indicator
- fourteenth character: carriage return
- fifteenth character: line feed

Eventual non-significative zero are put as spaces.

In the following table the various transmission formats are shown:

Weight mode (valid for both continuous and on demand transmission)

1°	2°	3°	4°	5°	6°	7°	8°	9°	10°	11°	12°	13°	14°	15°
Sign	weight							measure unit			Stability	CR	LF	

### 11.4.2 On demand transmission mode

When in on demand mode, the transmitted data to computer do not include only informations of the weight value but also date/time and other informations that depend on the function you're currently using are transmitted to computer

Below are shown the data transmitted in each situation possible:

#### **WEIGHT:**

-----  
03-04-11 10:13:44  
-----  
Weight: 0.00 g

---

#### **PIECE COUNTING:**

-----  
03-04-11 10:49:28  
-----  
Pcs.: 10  
Weight: 100.02 g  
MPW: 10.00 g

---

#### **DENSITY:**

-----  
03-04-11 10:51:15  
-----  
d: 1.4504 g/cm3

---

**FORMULATION:**

-----  
03-04-11 10:54:57  
-----

Manual

- 1. 31.05 g
- 2. 100.02 g
- 3. 26.89 g

-----  
T = 157.96 g

NOTE: To transmit the print of total of weights, press and keep pressed the PRINT button

---

**THRESHOLDS:**

Value under threshold

Value inside thresholds

Value over threshold

-----  
03-04-11 11:02:19  
-----

-----  
03-04-11 11:01:50  
-----

-----  
03-04-11 11:01:50  
-----

Lim.1 : 10.00 g  
Lim.2 : 100.00 g  
Weight: -0.01 g  
TEST: KO! ---

Lim.1 : 10.00 g  
Lim.2 : 100.00 g  
Weight: 31.08 g  
TEST: OK!

Lim.1 : 10.00 g  
Lim.2 : 100.00 g  
Weight: 131.10 g  
TEST: KO! +++

---

**PERCENTUAL WEIGHT**

-----  
03-04-11 11:58:39  
-----

Perc. 100.0 %  
Weight: 18.69 g  
Refer.: 18.69 g

---

**ANIMAL WEIGHING:**

-----  
03-04-11 12:01:06  
-----

Time = 20 Sec  
M: 56.53 g

---

**MAXIMUM LOAD:**

-----  
03-04-11 12:01:57  
-----

Max.: 2.76 g



### 11.4.3 On demand transmission with G.L.P.

In the on demand transmission with G.L.P., the data transmitted to computer are the same as described as in the on demand transmission without G.L.P. mode but with the add of G.L.P. parameters before of each transmission, as described below:

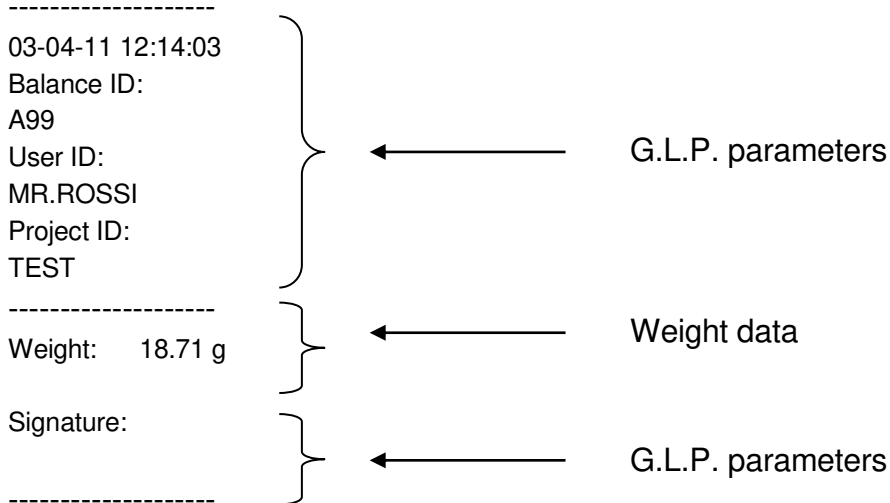

### 11.5 Connecton of balance with serial printer

It is possible to connect the balance to a printing peripheral. To print the weight, connect the connector of the balance to the serial printer as shown in the scheme below:

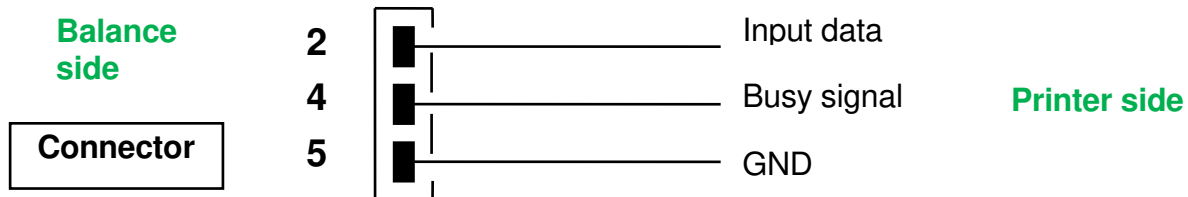

Here you can find description of the several modes of printing that can be selected:

- Print of weight data with a generic serial printer (from the menu, set the generic printing mode as described in the paragraph 9.2 and manage the busy signal).
- Print of weight data together with GLP indications with generic serial printer (from the menu, set the generic printing-GLP mode as described in the paragraph 9.2 and manage the busy signal)
- Print of weight data with printer model TLP50 (from the menu, set the printer TLP mode as described in the paragraph 9.2).
- Print of weight data together with GLP indications with printer model TLP50 (from the menu, set the printer TLP - GLP mode as described in the paragraph 9.2).

**Note: In all different printing modes just described, if the weight is not stable during transmission of data to printer, an acoustic signal is emitted and ERR05 is displayed and weight is not printed.**

### 11.5.1 PRINT FORMATS

Here are described the different types of print, depending on the print mode and on the function selected:

#### Generic printing or TLP 50 printer

##### Weighing mode:

-----  
03-04-11 10:13:44  
-----

Weight: 0.00 g

---

##### Piece counting:

-----  
03-04-11 10:49:28  
-----

Pcs.: 10  
Weight: 100.02 g  
MPW: 10.00 g

---

##### Density:

-----  
03-04-11 10:51:15  
-----

d: 1.4504 g/cm<sup>3</sup>

---

##### Formulation:

-----  
03-04-11 10:54:57  
-----

Manual

1. 31.05 g
2. 100.02 g
3. 26.89 g

-----  
T = 157.96 g

---

NOTE: To transmit the print of total of weights, press and keep pressed the PRINT button

**Thresholds:**

Value under threshold

Value inside thresholds

Value over threshold

-----  
03-04-11 11:02:19  
----------  
03-04-11 11:01:50  
----------  
03-04-11 11:01:50  
-----Lim.1 : 10.00 g  
Lim.2 : 100.00 g  
Weight: -0.01 g  
TEST: KO! ---Lim.1 : 10.00 g  
Lim.2 : 100.00 g  
Weight: 31.08 g  
TEST: OK!Lim.1 : 10.00 g  
Lim.2 : 100.00 g  
Weight: 131.10 g  
TEST: KO! +++

---

**Percentual weight:**-----  
03-04-11 11:58:39  
-----Perc. 100.0 %  
Weight: 18.69 g  
Refer.: 18.69 g

---

**Animal weighing:**-----  
03-04-11 12:01:06  
-----Time = 20 Sec  
M: 56.53 g

---

**Maximum load:**-----  
03-04-11 12:01:57  
-----Max.: 2.76 g

---

**11.5.2 Generic Printer or TLP 50 printer with G.L.P.**

In the print mode with G.L.P. the printed data are the same as shown in the print mode without G.L.P. but with the add of G.L.P. paramters as shown below:

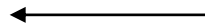
-----  
03-04-11 12:14:03  
Balance ID:  
A99  
User ID:  
MR.ROSSI  
Project ID:

G.L.P. parameters

TEST

-----  
Weight: 18.71 g

Signature:  
-----

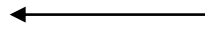



Weight data



G.L.P. parameters

## 12 Error codes

ERROR MESSAGE ON DISPLAY	MEANING	POSSIBLE SOLUTIONS
ERR01	Weight not stable after operation of tare	Protect the balance from air flows or from vibrations from the table.
ERR02	impossible to start the calibration due to instability of the balance	Protect the balance from air flows or from vibrations from the table.
ERR03	calibration weight not correct or balance unstable	Calibrate with correct weight or protect the balance from environmental disturbances. <b>In models with internal calibration</b> remove the screw in the left lower part of the balance (see part 5)
ERR04	weight of samples for the piece counting function not adequate or unstable	Select a larger number of samples or protect the balance from vibrations.
ERR05	impossible to print because of unstable weight	Protect the balance from environmental disturbance
ERR06	Weight is not stable in density mode	Protect the balance from environmental disturbance
ERR07	Weight is not stable in percent weighing mode	Protect the balance from environmental disturbance
ERR08	Anomaly with autocalibration motor	Contact service staff
ERR09	Weight is not stable in formulation mode	Protect the balance from environmental disturbance
ERR10	Weight of component out of tolerance in formulation mode	Reduce quantity
ERR F	Flash memory damaged	Ask assistance from authorized service staff
“UNLOAD”	weight loaded on the pan or pan not positioned properly	Remove the weight from the pan or position properly the pan and underpan.
“CAL But”:	the balance requires to be re-calibrated	Unload weights, if any, on the pan, and press the CAL button
	Over-load condition	Unload the weights loaded on the pan
	Under-load condition	Place properly pan and underpan

## 13 Maintenance and care

Regular maintenance of your balance will ensure best performance and accurate measurements.

### ▪ **Cleaning**

Before cleaning the balance unplug and disconnect the power supply from the balance. Do not use aggressive cleaning product (such as solvents or similar), use a damp towel with mild detergent. Use care to prevent liquids from entering the inside of the instrument during the cleaning. Wipe the balance dry with a soft towel. Powder and other particulates can be removed using a brush or vacuum cleaner.

### ▪ **Safety checks**

Safe use of the instrument cannot be guaranteed if:

- the balance power supply is clearly damaged
- the balance power supply is not functioning
- balance power supply is stored for long time in unsuitable environmental conditions.

In any of the above cases, contact your distributor or a specialized service technician to repair or replace necessary components so the instrument can be used safely..

## 14 Technical Specifications

All the models listed are only for internal use. Maximum altitude use limit: 4000m. Pollution level: 2.  
Over voltage category: II

Power supply provided:	INPUT: 230V ~ 50Hz or 115V ~ 60Hz, OUTPUT: 24V DC 550mA, Max power absorbed 13.2VA-
Environment conditions adaption:	Filters selection
Autozero:	Selectable from Menu
Serial output:	RS232C
Operating temperature:	+5°C - +35°C

## 15 Warranty

- The duration of the manufacturer's warranty is 24 months from the date of purchase shown on the invoice.
- The warranty covers all manufacturing defects. It does not cover mechanical or electronic parts damaged by incorrect installation, tampering, incorrect use, or damage due to usage.
- The warranty does not cover damages caused by impacts, balance drops or drop of objects on weighing pan.
- Shipment costs to and from the service center for warranty repairs is the responsibility of the customer.

## 16 Equipment disposal



This equipment is marked with the crossed out wheeled bin symbol to indicate that this equipment must not be disposed of with unsorted waste.

It's your responsibility to correctly dispose of your equipment at lifecycle -end by handing it over to an authorized facility for separate collection and recycling. It's also your responsibility to decontaminate the equipment in case of biological, chemical and/or radiological contamination, so as to protect from health hazards the persons involved in the disposal and recycling of the equipment.

For more information about where you can drop off your waste of equipment, please contact your local distributor from whom you originally purchased this equipment.

By doing so, you will help to conserve natural and environmental resources and you will ensure that your equipment is recycled in a manner that protects human health.

*Thank you*

