



CPR PROMPT +

Powered by **heartisense**[®]



LIST OF COMPONENTS

- User Guide
- CPR Prompt® Plus Add-on Kit. Requires 2 “AAA” batteries (not included).
- Lung Bag with Sensor Holder

Additional instructions packaged with the manikin.

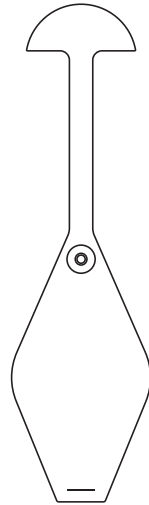
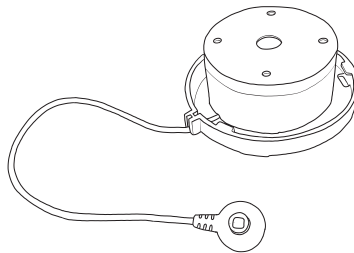

DOWNLOAD APPS

①

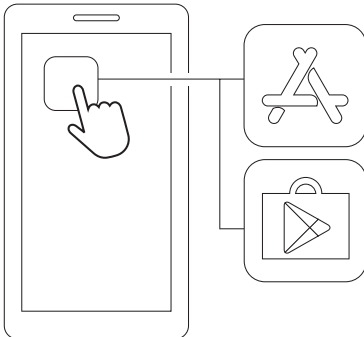

②

🔍 CPR add-on kit |

③



CPR add-on kit
Student



CPR add-on kit
Instructor

GET



Student and instructor apps run on Apple® iPhone® devices. Apple® iPad® version apps will be available February 2019. Android™ version apps will be available in the first half of 2019. (iPad®, Android™, and Apple® tablet/phone not included).

HOW TO INSTALL

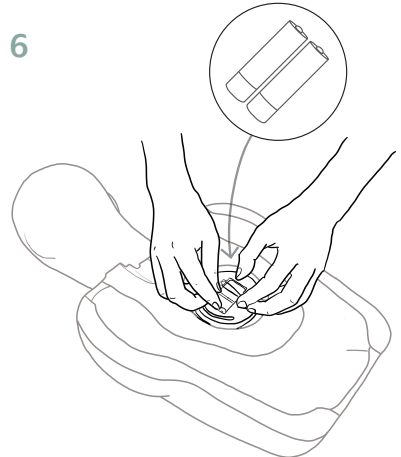
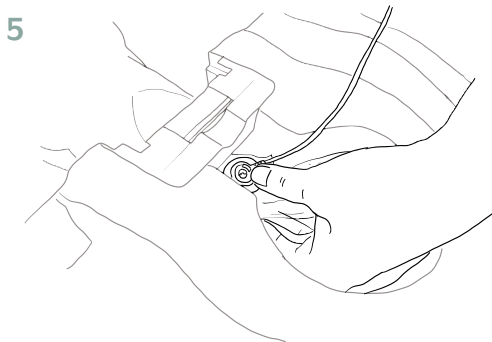
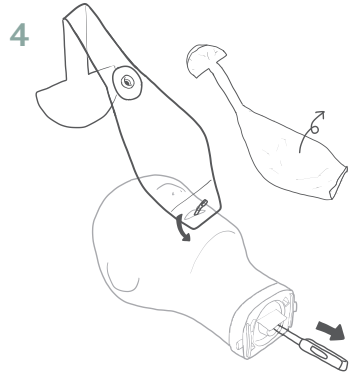
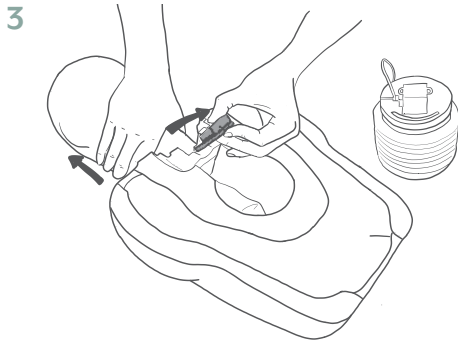
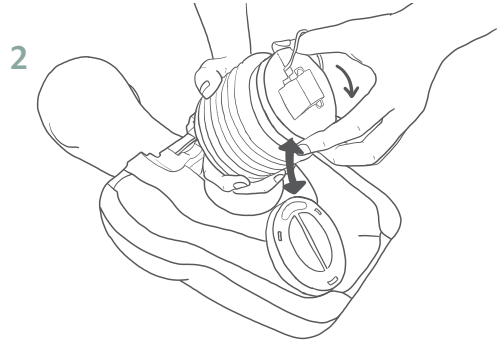
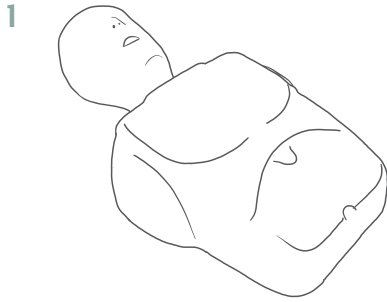

Actual product may vary slightly from photo. Nasco reserves the right to change product color, materials, supplies, or function as needed.

PRODUCT INFORMATION

Product Name	CPR Prompt® Plus Add-on Kit
Model	AK1G PT
Developer	I.M.LAB Inc.
Manufacturer/Country	I.M.LAB Inc./South Korea
Authorization Code	FCC./CE.

Class B Device

This device complies with Part 15 of the FCC Rules. Operation is subject to the following two conditions: (1) this device may not cause harmful interference, and (2) this device must accept any interference received, including interference that may cause undesired operation.

WARRANTY

1. Manufacturer offers a LIMITED WARRANTY against any defects in workmanship or materials under normal use for one (1) year from the date of purchase. Any component of the CPR Prompt® Plus add-on kit which proves defective within the warranty period will be repaired, free of charge. The customer is responsible for shipping and handling fees to the place which manufacturer designates.
2. Customer must provide proof of the date of purchase, place of purchase and the purchase price in order to obtain service under this limited warranty. No agent, representative, dealer of Manufacturer has the authority to alter the obligations or limitations of this limited warranty.
3. CUSTOMER'S SOLE AND EXCLUSIVE REMEDY AGAINST MANUFACTURE SHALL BE FOR THE REPAIR OR REPLACEMENT OF DEFECTIVE GOODS AS PROVIDED HEREIN. Repair of any component of any CPR Prompt® Plus add-on kit does not extend this limited warranty or begin a new limited warranty period.
4. Manufacturer reserves the right to refuse warranty service or replacement when product failure is due to abrasion, abnormal use, misuse, mishandling, misapplication, accident, neglect, improper installation, modification, use of unauthorized parts or attachments, adjustments or repair performed by anyone other than manufacturer or its authorized agent, or any causes other than defective workmanship or material. This limited warranty does not cover failure or damage resulting from unsuitable operating environments or storing environments or natural disasters or acts of God. MANUFACTURER SHALL NOT BE LIABLE FOR INCIDENTAL OR CONSEQUENTIAL DAMAGES ARISING OUT OF THE USE OF THE CPR Prompt® Plus add-on kit OR THE BREACH OF THIS OR ANY OTHER EXPRESSED OR IMPLIED WARRANTY.

