

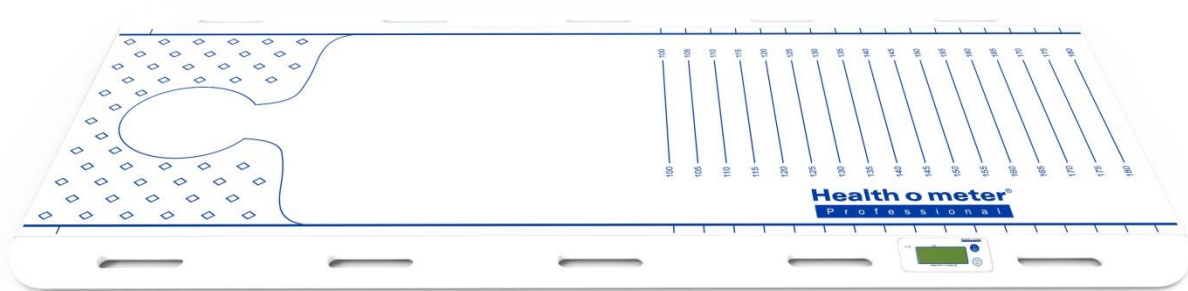

PTS-1000KL

Patient Transfer Scale



User Instructions



Health o meter® Professional PTS-1000KL

© Pelstar, LLC 2023

weigh**easier**®

Thank you for purchasing this Health o meter® Professional product. Please read this manual carefully, and keep it for easy reference or training.

TABLE OF CONTENTS

Cautions and Warnings	3
Specifications	4
Wall Mounting	5
Recharging the Scale	7
LCD Display	8
Setting Up the Scale.....	9
Preparing to Use the Scale	11
Operating the Scale.....	12
EMC Guidance	14
Maintenance.....	18
Calibration	19
Troubleshooting	23
Warranty.....	24

Note: This scale has been factory calibrated, and does not require calibration prior to use.

Please register your scale for warranty coverage at:

www.homscales.com

For User Instructions updates and revisions please go to:

www.homscales.com

CAUTIONS AND WARNINGS

INTENDED USE

This Health o meter® Professional patient transfer scale is intended to be used in a professional medical environment by trained medical staff. This product was designed to weigh immobile patients who are safely positioned on the scale. Do not modify the product or use it for anything other than its intended purpose.

To prevent patient/caregiver injury or damage to your scale, please follow the instructions in this user manual very carefully.

- When using electrical components under increased safety requirements, always comply with appropriate regulations.
- Inappropriate installation/use will render the warranty null and void.
- Ensure the voltage marked on the power supply unit matches your mains supply.
- This device is designed for use indoors.
- Observe the permissible ambient temperatures for use.
- The device meets the requirements for electromagnetic capability. Do not exceed the maximum values specified in the applicable standards.
- Batteries should be kept away from small children. If swallowed, promptly seek medical assistance.
- Transfer patient only between surfaces of similar height.
- The wheels of the stretcher/bed must be locked before use.
- The distance from bed to bed, or stretcher to bed, must not exceed 8 in/20 cm.
- The scale must be supported by a minimum of 8 in/20 cm on each bed/stretcher.
- Do not exceed the weight capacity specified for this scale.
- For accurate weighing, verify before each use the proper operation according to the procedure described in this manual.
- Do not use in the presence of flammable or explosive materials.
- If the scale becomes damaged, it should not be operated until properly serviced.
- Ensure that the battery charger and scale do not come in contact with liquids, excessive temperature, or excessive humidity.
- Patient should be lying flat for better accuracy.
- The Patient Transfer Scale should be used with a slide sheet.
- Do not drop the scale as this may damage internal parts.
- **Warning:** The Patient Transfer Scale should not be used to carry patients.

In no event whatsoever shall Pelstar, LLC be liable for damages or injuries arising from or connected with the assembly, use, or misuse of its products.

SPECIFICATIONS

Scale Specifications

Capacity and Resolution	550 lb x 1 lb (250 kg x 0.5 kg)
Power Supply	Power Source: 3.7 volt rechargeable battery (included) Power Requirements: 100 – 240 VAC battery charger (included)
Environmental	Operating temperatures: 41°F to 95°F (5°C to 35°C) Storage temperatures: 30°F to 125°F (0°C to 50°C) Maximum Humidity: 85% RH
Physical Dimensions	Length: 71" (1805 mm) Width: 27.5" (700 mm) Height: 1" (30 mm) Weight: 25 lb (11.4 kg)
Display	1" x 3" (27.7 mm x 75 mm) LCD

Definition of Symbols



Use only adapter supplied with this product.



Temperature range
(0°C to 50°C / 32°F to 122°F)



Type: EM1005AVRU
5V DC @ 1.2A

WALL MOUNTING THE SCALE

You can hang the Patient Transfer Scale on the wall either horizontally or vertically, using the hooks provided. To hang horizontally, your hooks will need to be positioned exactly 55" (1400mm) apart, center to center. To hang vertically, your hooks will need to be positioned 24" (610mm) apart, center to center. It is suggested to hang the scale near a power outlet to be able to easily attach the battery charger.

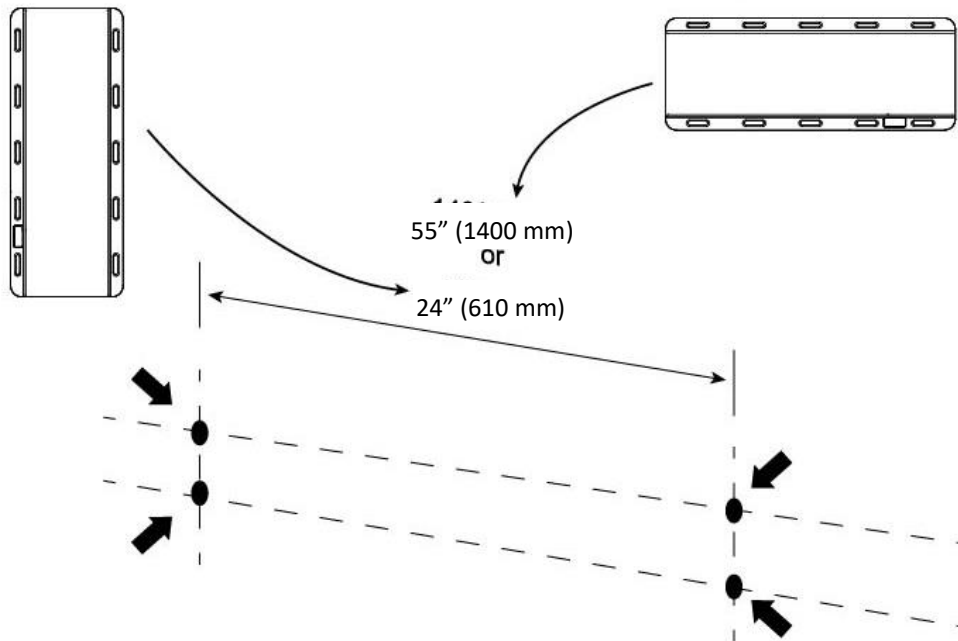

Use the Patient Transfer Scale and the hooks to determine the positioning of the hooks on the wall, and mark drill holes. Drill holes should be exactly 55" (1400mm) or 24" (610mm) apart, as per above.

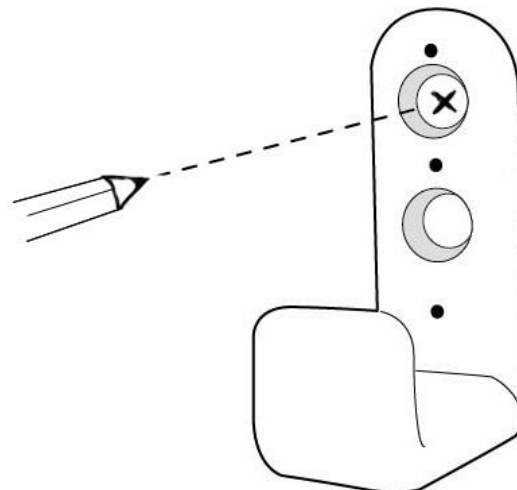

WALL MOUNTING THE SCALE (CONT.)

Drill two 1/4" (6.5mm) holes for each hook.

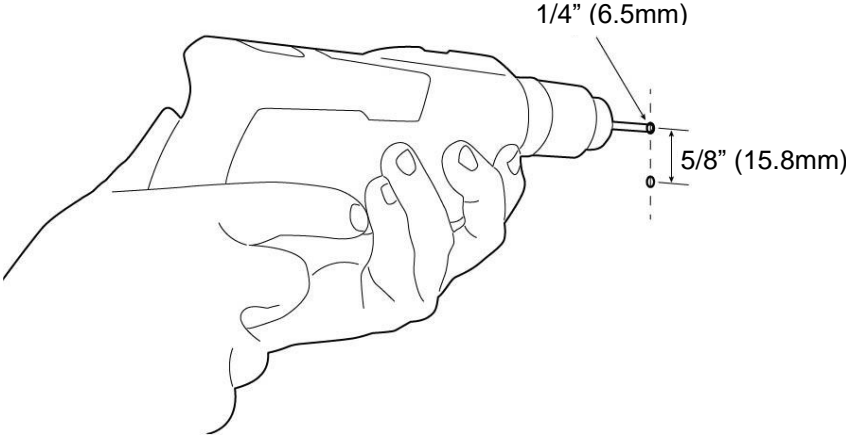

Affix the hooks to the wall using the screws and wall plugs provided, and use the plastic covers to hide the screwheads.

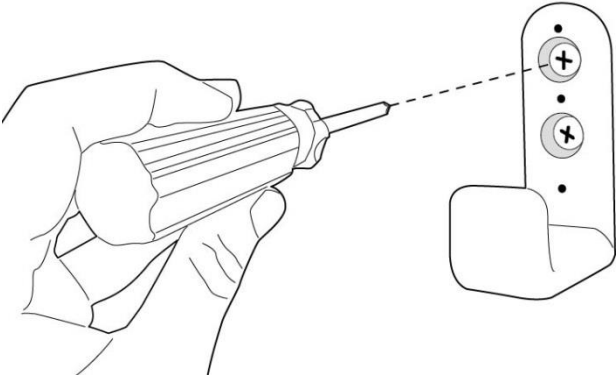

Your Patient Transfer Scale can now be hung on the wall.

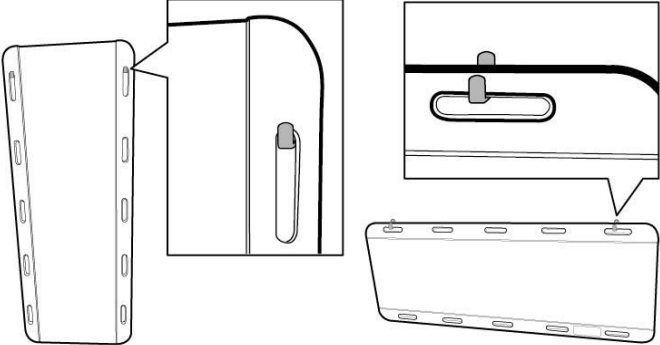

RECHARGING THE SCALE

We recommend fully charging the scale before first use. To fully charge the scale, please allow 8 hours.

When the low battery indicator on the LCD display indicates that the scale needs recharging, move the scale to a location where it can be charged. You will find the charging port on the underside of the scale.

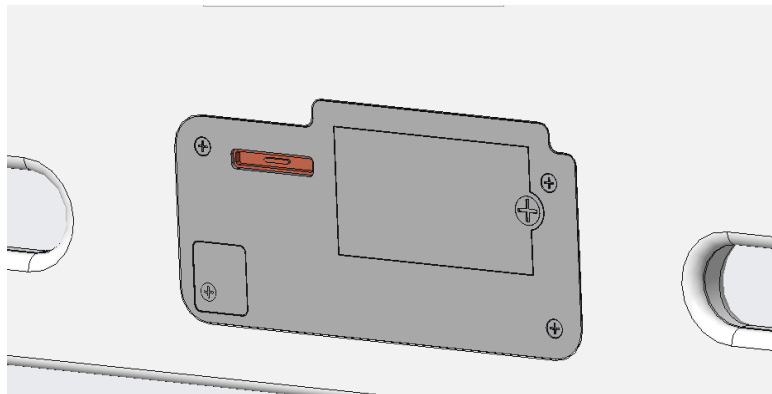
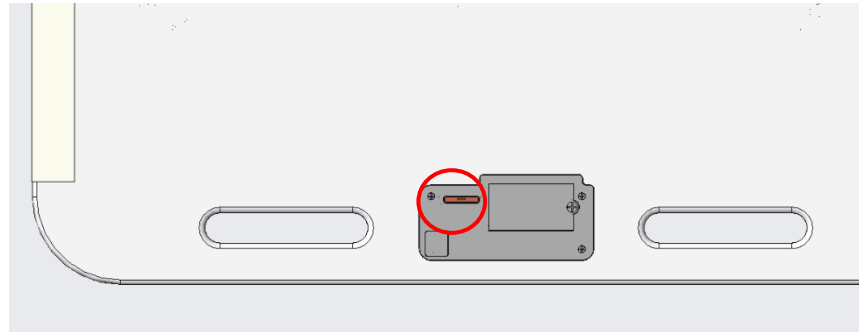

The port for the charging cable is magnetic. Clip the end of the cable in place and plug the other end of the cable into a power outlet. Please do not use any form of charging cable other than the one supplied with the scale. The scale cannot be used while recharging.

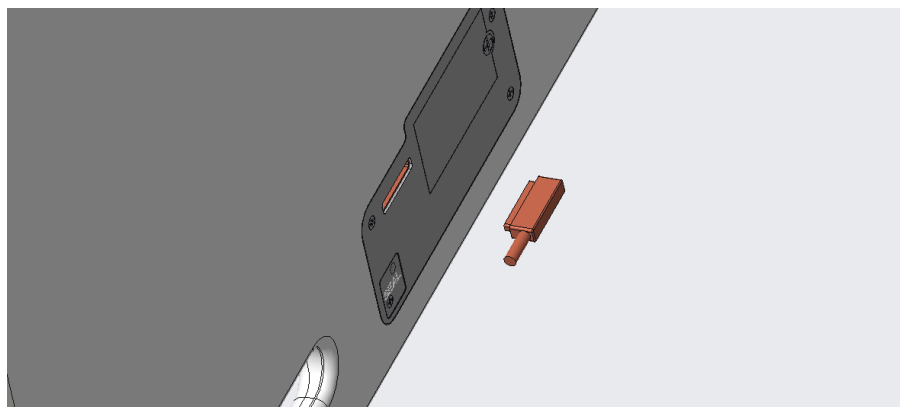

LCD DISPLAY

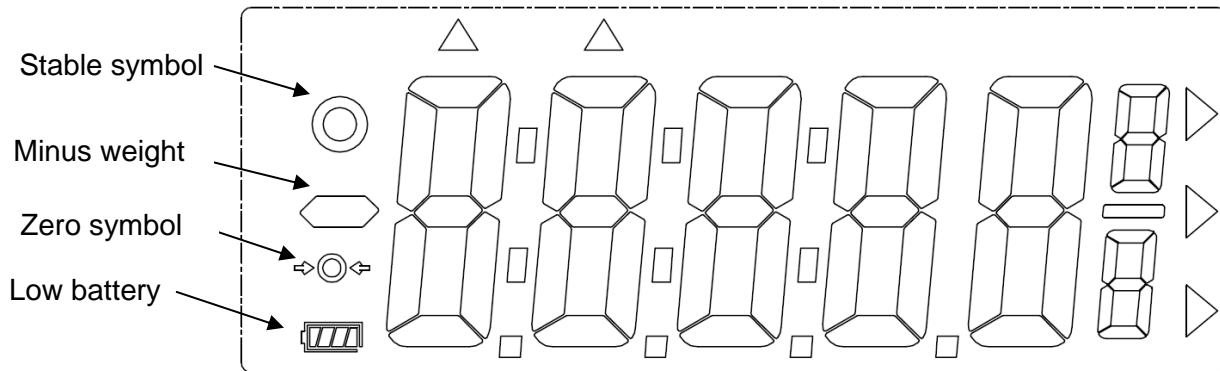

Stable symbol: To indicate the weight reading is stable.

Minor weight: The weight is under zero.

Zero symbol: The weight is at zero point.



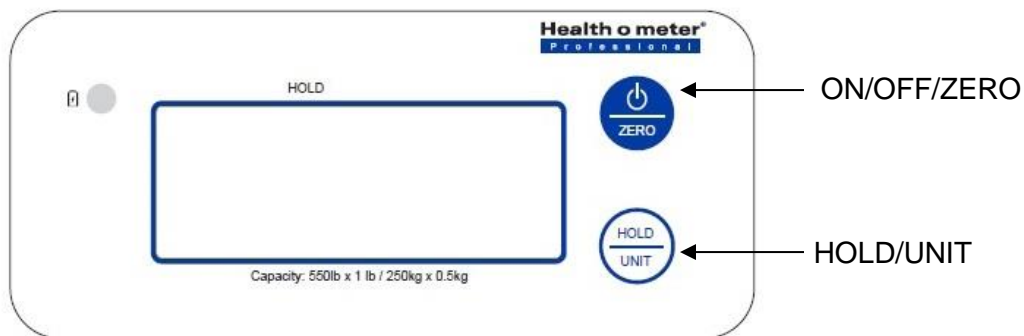





Low battery: Please recharge the scale.



SETTING UP THE SCALE









Setting Auto Off Time/Disabling Auto Off

The Auto Off time can be set for 30 minutes, 60 minutes or off. Follow this procedure to set the Auto Off time.

1. With the scale powered off, press and hold  until the display shows “P-X.XX” (*X = version number*), while still pressing , press  three times then release both buttons.
2. “SETUP” will appear on the display followed by “AOFF”.
3. Press . Press  to scroll through the time options. 30m, 60m, or Off.
4. When the desired setting is selected, press .
5. Press  three times and “End” will appear on the display.
6. Press  to return to weighing mode.









Enabling/Disabling Sound

The display can be set to stay silent or beep while operating the scale. Follow this procedure to enable or disable sound.

1. With the scale powered off, press and hold  until the display shows “P-X.XX” (*X = version number*), while still pressing , press  three times then release both buttons.
2. “SETUP” will appear on the display followed by “AOFF”.
3. Press  and “burr” will appear on the display.
4. Press  and “OFF” or “On” will appear on the display.
5. Press  to change between off or on.
6. When the desired setting is selected, press . “burr” will appear on the display.
7. Press  two times and “End” will appear on the display.
8. Press  to return to weighing mode.

Enabling/Disabling Backlight

The backlight on the display can be enabled, disabled or set to Auto. Follow this procedure to enable or disable the backlight.

1. With the scale powered off, press and hold  until the display shows “P-X.XX” (*X = version number*), while still pressing , press  three times then release both buttons.
2. “SETUP” will appear on the display followed by “AOFF”.
3. Press  twice and “bAhL” will appear on the display.
4. Press  and “OFF”, “On” or “Auto” will appear on the display.
5. Press  to change between off, on, or automatic.
6. When the desired setting is selected, press . “bAhL” will appear on the display.
7. Press  one time and “End” will appear on the display.
8. Press  to return to weighing mode.









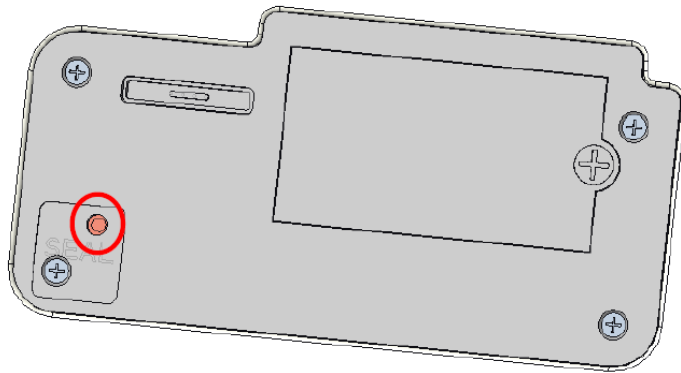

SETTING UP THE SCALE (CONTINUED)

Setting Scale to Kilogram Unit Measurement

The scale can be set to measure in kilograms instead of pounds. Follow this procedure so the scale will default to KG weight measurement.

1. With the scale powered on, press the TEST PIN once. The display will read **SEt** indicating that you have entered the Engineering Settings. The location of the TEST PIN is shown in the below image marked in red circle.



2. When the LCD displays "Unit" press and release  to enter the Unit settings.
3. When the LCD displays "Kg" press and release  to enter KG unit settings.
4. Press and release  until the display reads "On". Press and release  to save the setting.
5. Press and release  so the display reads "LB".
6. When the LCD displays "LB" press and release  to enter LB unit settings.
7. If the "LB" unit is "On", press and release  to change it to "Off" and then press and release  to save the setting.
8. Press and release  to go back to the main settings menu.
9. In the main settings menu, press and release  until "End" is displayed and then press and release  to exit.
10. The scale will now default to KG.

PREPARING TO USE THE SCALE

The Patient Transfer Scale should be used in line with your facility's current moving and handling policies. Essentially, it should be used in the same way you would use a transfer board, taking into account of course that you will need to pause for a few seconds during the transfer process, to allow the scale to capture the patient's weight.

- The Patient Transfer Scale should only be used by trained professionals.
- Ensure brakes on castors are applied before you begin the transfer process.
- Ensure that stretcher/bed frames are touching before you start the transfer process.
- There should be no more than 8"/200mm between mattresses. There should also be 8"/200mm or more of the Patient Transfer Scale on each bed or stretcher before use.
- When transferring, the two surfaces must be of similar height. A tilt of less than 3% (one side raised by around 1"/25mm) is ok; a tilt greater than this will affect the scale's accuracy. To avoid showing an inaccurate reading, the scale will display an error message if tilt exceeds 3% (see Error Messages).
- Patient should be lying flat for better accuracy.
- The Patient Transfer Scale should be used with a slide sheet.
- **Warning:** The Patient Transfer Scale should not be used to carry patients.

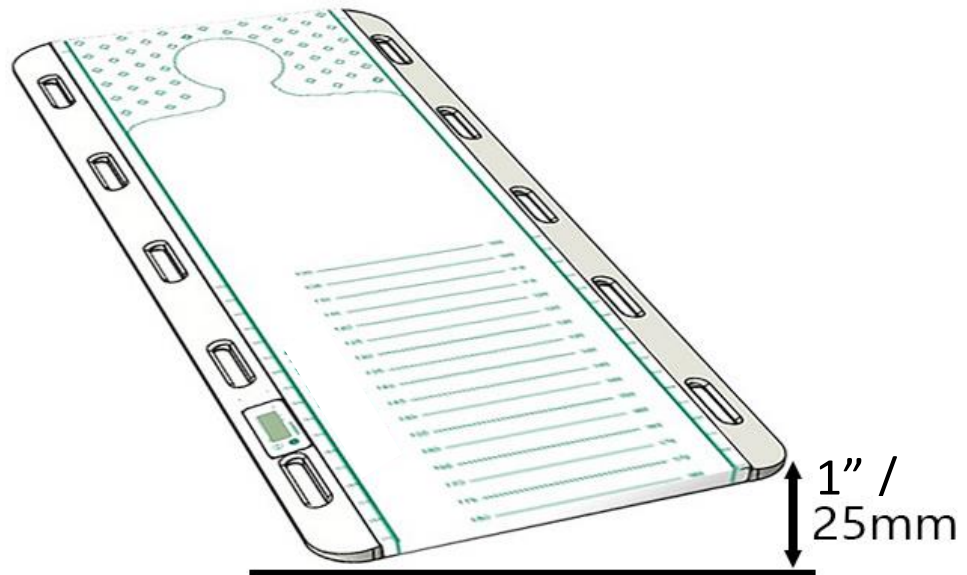

Guidance for safe use can also be found on the scale itself.

CAUTION

- Check the scale for damage before use.
- Do not overload. Maximum capacity: 250kg / 550lb.
- Transfer patient only between surfaces of similar height.
- The wheels of each stretcher/bed must be locked before use.
- The distance from bed to bed, or stretcher to bed, must not exceed 20cm / 8in.
- The scale must be supported by a minimum of 20cm / 8in on each bed/stretcher.

OPERATING INSTRUCTIONS

Switching the Scale on

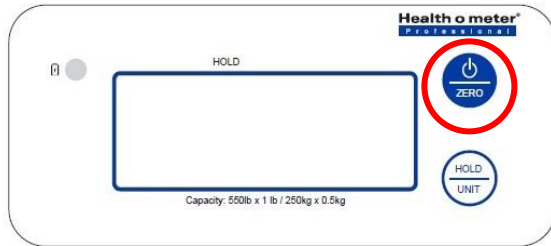

To switch the scale on, press the  button. When the display shows 0.0 the scale is ready to use.

Switching the Scale off

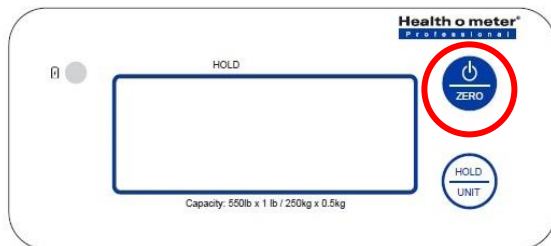

Press and hold  button for three seconds to power off the scale.

Setting the Scale to Zero

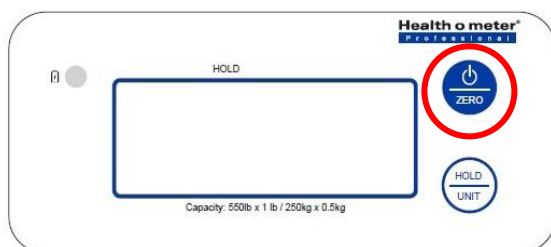

If for any reason the scale shows a reading other than 0.0 it can be reset to zero. Press the  button once and the scale will return to 0.0.

OPERATING INSTRUCTIONS (CONTINUED)

Using the Hold Function

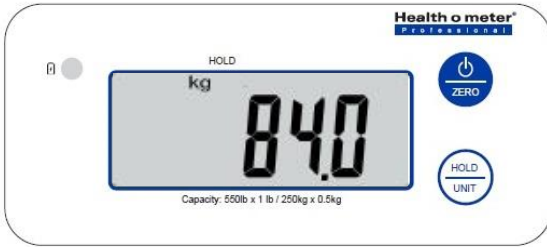

The scale's Hold function stabilizes the weight reading on the display, allowing you to take an accurate reading without fluctuations.

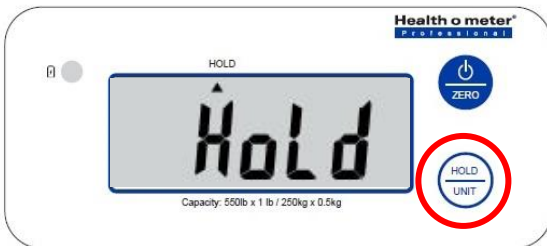



With a patient on the scale, press . The display will show 'HOLD'.

NB: Alternatively, you can activate the Hold function before the patient is on the scale.

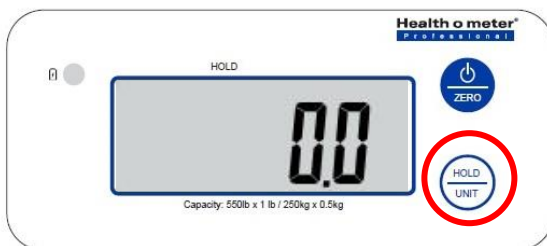

When the scale has determined the weight of the patient, a stable weight reading will show. This will remain on the display after the patient has left the scale.



Press  to disable the Hold function.

EMC Guidance & Manufacturer's Declaration

Guidance and manufacturer's declaration-electromagnetic emissions		
<p>The MEDICAL SCALE PTS-1000KL is intended for use in the electromagnetic environment specified below.</p> <p>The customer or the user of the MEDICAL SCALE should ensure that it is used in such an environment.</p>		
Emission test	Compliance	Electromagnetic environment-guidance
RF emissions CISPR 11	Group 1	The MEDICAL SCALE PTS-1000KL uses RF energy only for its internal function. Therefore, its RF emissions are very low and are not likely to cause any interference in nearby electronic equipment.
RF emissions CISPR 11	Class B	The MEDICAL SCALE PTS-1000KL is suitable for use in all establishments, including domestic establishments and those directly connected to the public low-voltage power supply network that supplies buildings used for domestic purposes.
Harmonic emissions IEC 61000-3-2	Class A	
Voltage fluctuations /flicker emissions IEC 61000-3-3	Compliance	

Guidance and manufacturer's declaration-electromagnetic immunity			
<p>The MEDICAL SCALE PTS-1000KL is intended for use in the electromagnetic environment specified below.</p> <p>The customer or the user of the MEDICAL SCALE PTS-1000KL should ensure that it is used in such an environment.</p>			
Immunity test	IEC 60601 test level	Compliance level	Electromagnetic environment-guidance
Electrostatic discharge(ESD) IEC 61000-4-2	± 6 kV contact ± 8 kV air	± 6 kV contact ± 8 kV air	Floors should be wood, concrete or ceramic tile. If floors are covered with synthetic material, the relative humidity should be at least 30%
Electrical fast transient/burst IEC 61000-4-4	± 2kV for power supply lines + 1kV for input/output lines	± 2kV for power supply lines Not applicable	Mains power quality should be that of a typical commercial or hospital environment.

Surge IEC 61000-4-5	± 1kV line(s) to line(s) ± 2kV line(s) to earth	± 1kV differential mode Not applicable	Mains power quality should be that of a typical commercial or hospital environment.
Voltage Dips, short interruptions and voltage variations on power supply input lines IEC 61000-4-11	<5% UT(>95% dip in UT) for 0,5 cycle 40% UT(60% dip in UT) for 5 cycles 70% UT(30% dip in UT) for 25 cycles <5% UT(>95% dip in UT) for 5 s	<5% UT(>95% dip in UT) for 0,5 cycle 40% UT(60% dip in UT) for 5 cycles 70% UT(30% dip in UT) for 25 cycles <5% UT(>95% dip in UT) for 5 s	Mains power quality should be that of a typical commercial or hospital environment. If the user of the MEDICAL SCALE PTS-1000KL requires continued operation during power mains interruptions, it is recommended that the MEDICAL SCALE PTS-1000KL be powered from an uninterruptible power supply or a battery.
Power frequency(50/60 Hz) magnetic field IEC 61000-4-8	3 A/m	3 A/m	The MEDICAL SCALE PTS-1000KL power frequency magnetic fields should be at levels characteristic of a typical location in a typical commercial or hospital environment.
NOTE UT is the a.c. mains voltage prior to application of the test level.			

Guidance and manufacturer's declaration-electromagnetic immunity			
The MEDICAL SCALE PTS-1000KL is intended for use in the electromagnetic environment specified below. The customer or the user of the MEDICAL SCALE PTS-1000KL should assure that is used in such and environment.			
Immunity test	IEC 60601 test level	Compliance level	Electromagnetic environment-guidance
Conducted RF IEC 61000-4-6	3 Vrms 150 KHz to 80 MHz	3 Vrms	Portable and mobile RF communications equipment should be used no closer to any part of the MEDICAL SCALE PTS-1000KL including cables, than the recommended separation distance calculated from the equation applicable to the frequency of the transmitter. Recommended

Radiated RF IEC 61000-4-3	3 V/m 80MHz to 2,5 GHz	3 V/m	<p>separation distance: $d = 1,2 \sqrt{P}$ $d = 1,2 \sqrt{P}$ 80MHz to 800 MHz $d = 2,3 \sqrt{P}$ 800MHz to 2,5 GHz</p> <p>Where P is the maximum output power rating of the transmitter in watts (W) according to the transmitter manufacturer and d is the recommended separation distance in metres (m).</p> <p>Field strengths from fixed RF transmitters, as determined by an electromagnetic site survey^a, should be less than the compliance level in each frequency range^b.</p> <p>Interference may occur in the vicinity of equipment marked with the following symbol:</p> 
<p>NOTE1 At 80 MHz and 800 MHz, the higher frequency range applies. NOTE2 These guidelines may not apply in all situations. Electromagnetic propagation is affected by absorption and reflection from structures, objects and people.</p>			
<p>a Field strengths from fixed transmitters, such as base stations for radio (cellular/cordless) telephones and land mobile radios, amateur radio, AM and FM radio broadcast and TV broadcast cannot be predicted theoretically with accuracy. To assess the electromagnetic environment due to fixed RF transmitters, an electromagnetic site survey should be considered. If the measured field strength in the location in which the MEDICAL SCALE PTS-1000KL is used exceeds the applicable RF compliance level above, the MEDICAL SCALE PTS-1000KL should be observed to verify normal operation. If abnormal performance is observed, additional measures may be necessary, such as re-orienting or relocating the MEDICAL SCALE PTS-1000KL.</p> <p>b Over the frequency range 150 kHz to 80 MHz, field strengths should be less than 3 V/m.</p>			

Recommended separation distance between portable and mobile RF communications equipment and the MEDICAL SCALE

The MEDICAL SCALE PTS-1000KL is intended for use in an electromagnetic environment in which radiated RF disturbances are controlled. The customer or the user of the MEDICAL SCALE PTS-1000KL can help prevent electromagnetic interference by maintaining a minimum distance between portable and mobile RF communications equipment (transmitters) and the MEDICAL SCALE as recommended below, according to the maximum output power of the communications equipment.

Rated maximum output power of transmitter W	Separation distance according to frequency of transmitter m		
	150 kHz to 80 MHz $d = 1,2\sqrt{P}$	80 MHz to 800 MHz $d = 1,2\sqrt{P}$	800 MHz to 2,5 GHz $d = 2,3\sqrt{P}$
0,01	0,12	0,12	0,23
0,1	0,38	0,38	0,73
1	1,2	1,2	2,3
10	3,8	3,8	7,3
100	12	12	23

For transmitters rated at a maximum output power not listed above, the recommended separation distance d in metres (m) can be estimated using the equation applicable to the frequency of the transmitter, where p is the maximum output power rating of the transmitter in watts (W) according to the transmitter manufacturer.

NOTE1 At 80 MHz and 800 MHz, the separation distance for the higher frequency range applies.

NOTE2 These guidelines may not apply in all situations. Electromagnetic propagation is affected by absorption and reflection from structures, objects and people.

MAINTENANCE

Maintenance

The following pages provide instructions for maintenance, cleaning, calibrating, and troubleshooting of the scale. Maintenance operations other than those described in this manual should be performed by qualified service personnel.

Caution: Before first use, or after long periods of non-use, check the scale for proper operation and function. If the scale does not operate correctly, refer to qualified service personnel.

1. Check overall appearance of the total scale for any obvious damage, wear, and tear.
2. Inspect the battery charger cord for cracking or fraying, or for broken/bent prongs.

Cleaning and Disinfecting

When cleaning or disinfecting the Patient Transfer Scale, please follow the guidance below.

Caution: Always disconnect the scale from the main power supply before cleaning.

- The Patient Transfer Scale must be cleaned after each patient use with a neutral based detergent and water or a detergent wipe. If contaminated with blood or bodily fluids then disinfect as per local guidelines.
- Use a non-abrasive cloth.
- Please do not use corrosive liquids, large amounts of water or high pressure washers.
- Do not submerge the scale in water. If you think the scale may have suffered water damage, stop using it immediately and contact Health o meter® Professional Scales Customer Service at 1-800-815-6615.

Disposal



This Health o meter® Professional scale must be disposed of properly as electronic waste. Follow the national, regional or local regulations that apply to you for disposal of electronic waste or batteries. Do not dispose of this device in the domestic waste stream.

CALIBRATION

This scale has been factory calibrated, and does not require calibration prior to use. If necessary the scale can be recalibrated following the steps below.

Step 1: Deactivate gravity compensation

Step 2: Proceed with calibration procedure

Step 3: Reassemble the top board (aluminum panel) and mat

Step 4: Calibrate zero

Before starting step 1, the mat and top board must be removed.

1. Peel back the mat.
2. Unfasten all 8 screws and lift off the top plate as shown in the image below. Set the screws aside for use in step 3 to reassemble the board.

Note: Do not use brute force to disassemble the top board (aluminum panel) under the mat, it might cause serious damage to the product. Always remove all of the screws before lifting the top board up.



Step 1: Deactivate Gravity Compensation

1. Power on the scale, then access the underside of the scale. Remove the SEAL, then press [TEST PIN] one time to enter Engineering Setting mode.

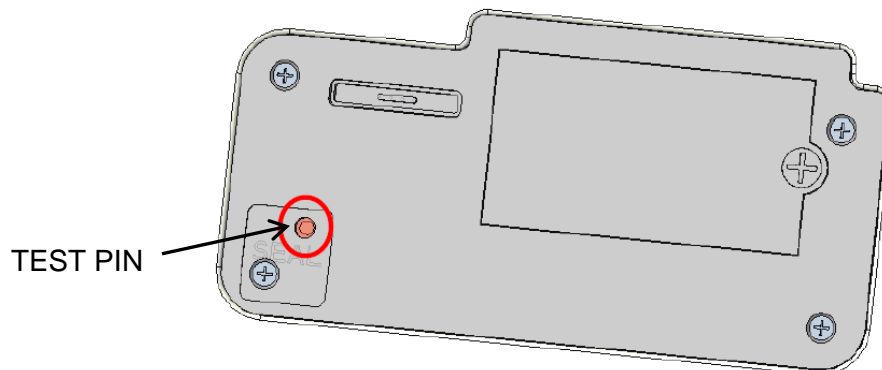

2. While LCD shows "UNIT", press [Hold] to select g_{rA_u} , press [Zero] to enter gravity setting and show 0_n
3. Press [Hold] to select OFF then press [Zero] to confirm and show g_{rA_u} .

CALIBRATION (CONT.)

- Press [Hold] to select **End**, then press [Zero] to finish deactivating Gravity Compensation and go back to normal mode.

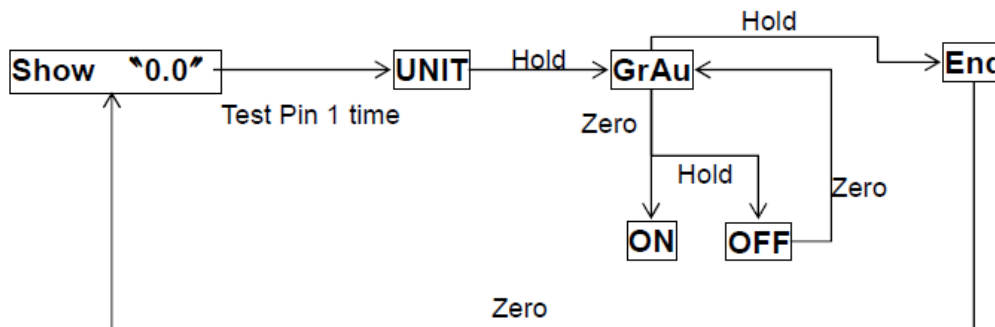

Step 2: Proceed calibration procedure (60kg)

- Power on the scale, press [TEST PIN] two times to enter Calibration mode.
- While LCD shows "Zero count", press [Zero] to show "Span count."
- Using a calibration plate, load 60 kg on the first set of load cells (LCD shows Span count), and wait for a stable reading.

CAUTION

- Remember to place a hard platform (such as the calibration plate) on the load cell sets before calibrating.
- Please refer to the following instruction to load weight on the load cell sets:

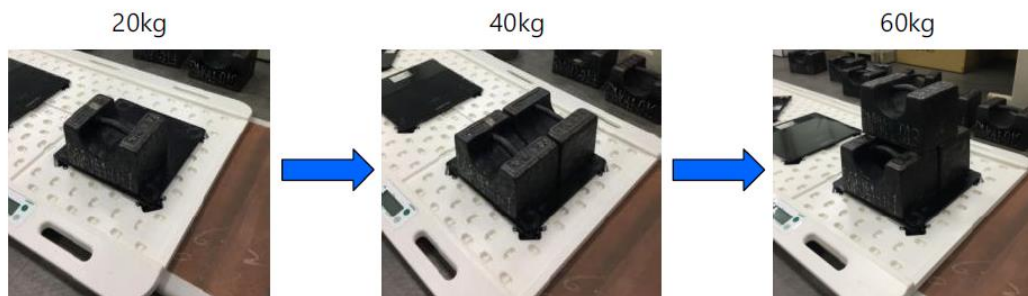

CALIBRATION (CONT.)

4. Press [Zero] to finish calibrating the first set while the LCD shows “CAL-1”.
5. Repeat the same procedure to calibrate the second to fourth set of load cells.
6. After all four sets of calibration are done, LCD shows current weight. Power off the scale.

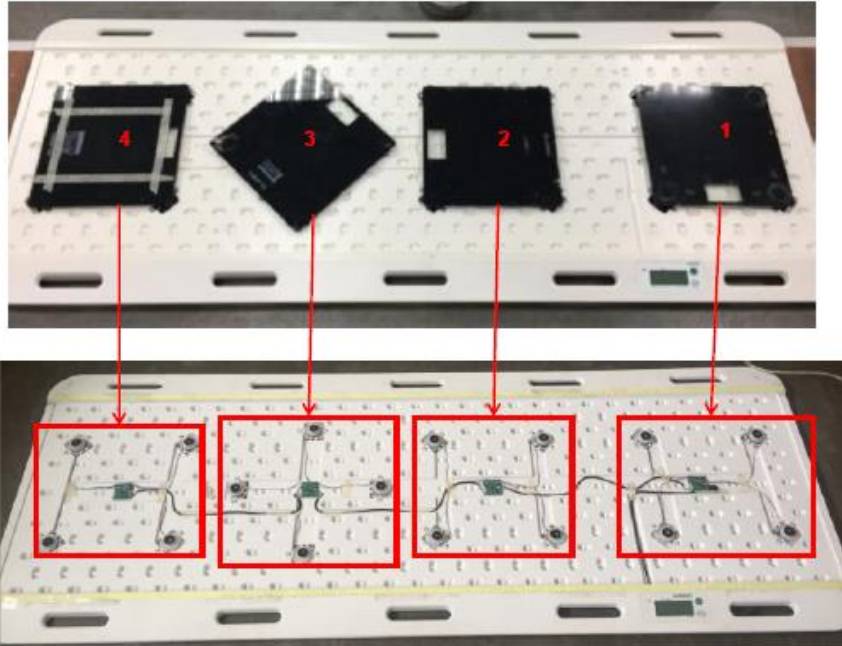
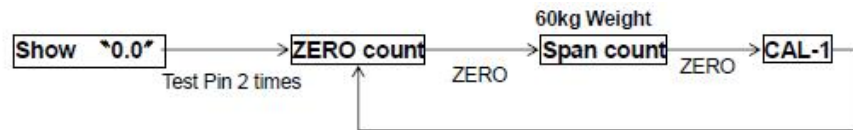

Step 3: Reassemble the top board (aluminum panel) and mat

1. Place the aluminum top plate back onto the scale and replace and fasten all 8 screws.

Caution: Do not overtighten the screws.

2. Reapply the mat following the procedure below.
 - A. Apply the double-sided strips in the recess either side of the aluminum plate as shown in the image below.



- B. Peel back the top film of the double-sided strips and lightly place the mat on top, ensuring that it is perfectly in place before pressing it into place.

CALIBRATION (CONT.)

- C. Turn the scale over and place the double-sided strips as shown on the image below.
- D. Peel back the film on the double-sided strips and then secure both ends of the mat into place.



Step 4: Calibrate Zero



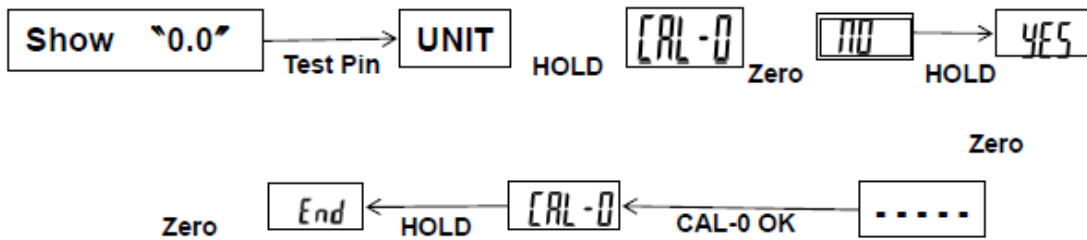



1. Power on, press [TEST PIN] one time to enter Engineering Setting mode.
2. While LCD shows "UNIT", press [HOLD] to select [CAL-0], press [Zero] to enter CAL-0 setting and shows "no".
3. Press [Hold] to select "yes", then press [Zero] to confirm and shows "---".
4. While LCD shows [CAL-0], press [Hold] to finish this procedure and shows [End].
5. Press [Zero] to return to normal mode.



TROUBLESHOOTING

Troubleshooting

Before contacting service personnel, refer to the following instructions to check and to correct any failures. If failures cannot be corrected, contact Health o meter® Professional Technical Support at 1-800-638-3722.

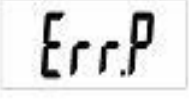
Error Message	Reason	Action
	Tilt error: The scale has been tilted by 3% or more	Please ensure the scale is as level as possible before use.
	Low battery: This warning shows that the voltage of battery is too low to use	Please recharge the scale.
	Overload: The total load exceeds the maximum capacity of scale	Please reduce the load on the scale.
	Counting error (too high): Indicates that the signal from the load cells is too high	This error is normally caused by a serious fault. Please contact your service provider.
	Counting error (too low): Indicates that the signal from the load cell is too low	This error is normally caused by a serious fault. Please contact Technical Support.
	Zero count over calibration zero range (+10% with power on)	Please re-calibrate the scale.
	Zero count under calibration zero range (-10% with power on)	Please re-calibrate the scale.
	EEPROM Error: Indicates that there is a fault with the software	This error is normally caused by a serious fault. Please contact Technical Support.

WARRANTY

Limited Warranty

What does the Warranty Cover?

This Health o meter® Professional scale is warranted from date of purchase against defects of materials or in workmanship for a period of two (2) years. If product fails to function properly, return the product, freight prepaid and properly packed to Pelstar, LLC (see "To Get Warranty Service", below, for instructions). If the manufacturer determines that a defect of material or in workmanship exists, the customer's sole remedy will be replacement of the scale at no charge. Replacement will be made with a new or remanufactured product or component. If the product is no longer available, replacement may be made with a similar product of equal or greater value. All replaced parts are covered only for the original warranty period.

Who is Covered?

The original purchaser of the product must have proof of purchase to receive warranty service. Please save your invoice or receipt. Pelstar dealers or retail stores selling Pelstar products do not have the right to alter, or modify or in any way change the terms and conditions of this warranty.

What is Excluded?

Your warranty does not cover normal wear of parts or damage resulting from any of the following: negligent use or misuse of the product, use on improper voltage or current, use contrary to the operating instructions, abuse including tampering, damage in transit, or unauthorized repair or alternations. Further, the warranty does not cover natural disasters, such as fire, flood, hurricanes and tornadoes. This warranty gives you specific legal rights, and you may also have other rights that vary from country to country, state to state, province to province or jurisdiction to jurisdiction.

To get Warranty Service make sure you keep your sales receipt or document showing proof of purchase. Call (+1) 800-638-3722 or (+1) 708-377-0600 to receive a return authorization (RA) number, which must be included on the return label. Attach your proof of purchase to your defective product along with your name, address, daytime telephone number and description of the problem. Carefully package the product and send with shipping and insurance prepaid to:

Pelstar, LLC

Attention R/A# _____

Return Department

9500 West 55th Street

McCook, IL 60525

Extended Warranty Available*

This scale is eligible for Health o meter® Professional ScaleSurance® Extended Warranty Program. ScaleSurance® extends the warranty period for an additional two years. This extension to the standard Limited Warranty can be purchased with new scales or for a facility's existing scale before its current warranty has expired. To learn more, visit www.homscales.com/scalesurance/ or contact your medical supply distributor.

*Not available in all countries.



Health o meter® is a registered trademark of Sunbeam Products, Inc. used under license. Health o meter® Professional products are manufactured, designed, and owned by Pelstar, LLC. We reserve the right to improve, enhance, or modify Health o meter® Professional product features or specifications without notice.

© Pelstar, LLC 2023