

fitted with	LED - Energy efficiency category A+
Illuminancefield @ 100 cm	18 cm, (7 in)
illuminance @ 100 cm	100 000 lx
color rendering index (CRI)	> 95
colour temperatur	3700/4300/4700 K
work equipment	electronic converter
mains lead	direct power supply
luminaire body	polyamide (PA)
weight (net)	15.9 kg, (35 lb)
Power consumption	40 W
usage	keypad at luminaire head
balance of articulation joints	spring
class of protection	I
Accessory	sterilizable handle
norms	EN 60601-1, EN 60601-2-41
special features	3 color shades, 4 dimming levels, Diamond optics, Focusable, High-quality arm system, sterilisable grip, maintenance free
Fastening	ceiling mount, when mounting ceiling tube could be cut to length 25-120 cm, intermediate ceiling adapter (on request)
System of protection	IP 20 (43)
order number	D16075000 - pure white

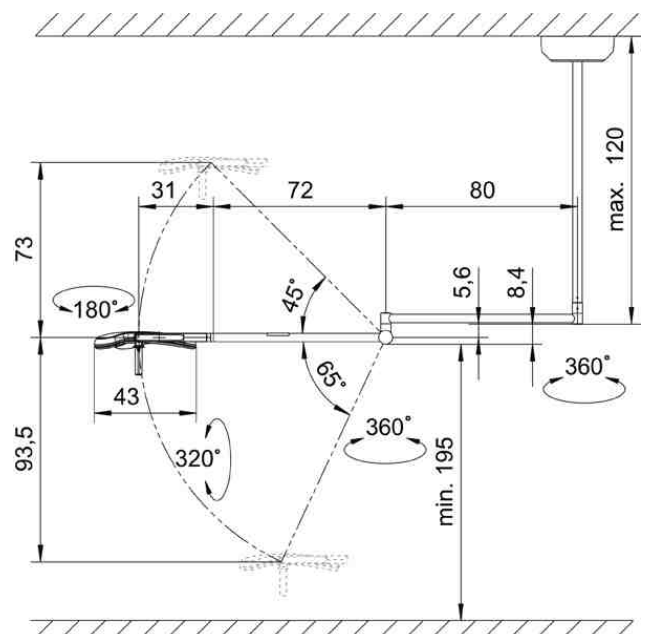

light distribution

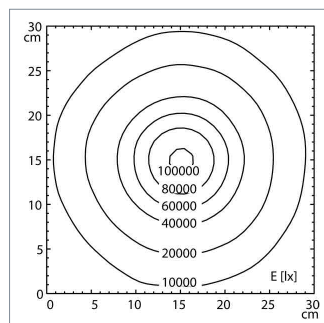

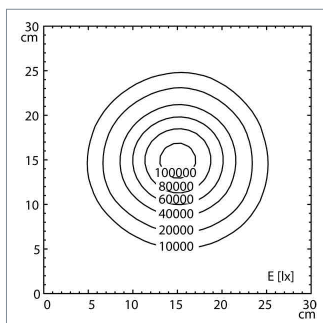
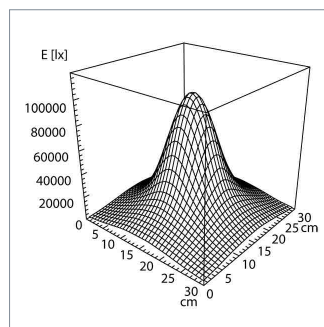
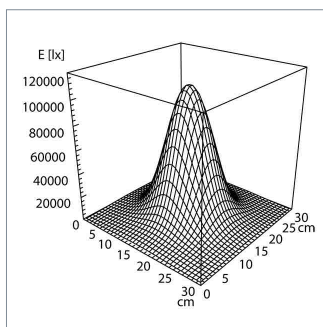

fitted with	LED - Energy efficiency category A+
Illuminancefield @ 100 cm	18 cm, (7 in)
illuminance @ 100 cm	100 000 lx
color rendering index (CRI)	> 95
colour temperatur	3700/4300/4700 K
work equipment	electronic converter
mains lead	direct power supply
luminaire body	polyamide (PA)
weight (net)	15.3 kg, (33.7 lb)
Power consumption	40 W
usage	keypad at luminaire head
balance of articulation joints	spring
class of protection	I
Accessory	sterilizable handle
norms	EN 60601-1, EN 60601-2-41
special features	3 color shades, 4 dimming levels, Diamond optics, Focusable, High-quality arm system, sterilisable grip, maintenance free
Fastening	wall
System of protection	IP 20 (43)
order number	D16080000 - pure white



light distribution

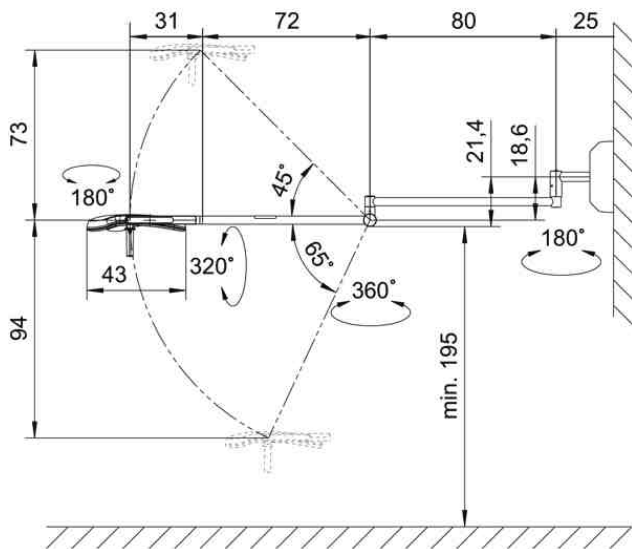
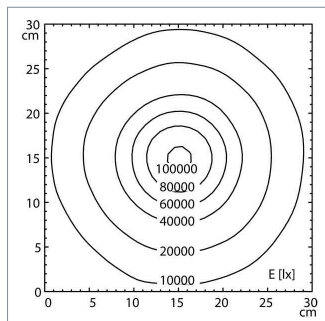
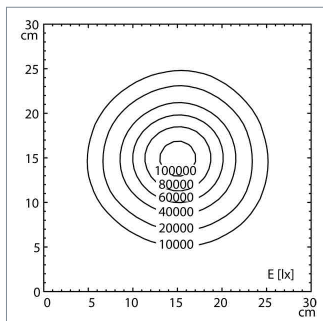
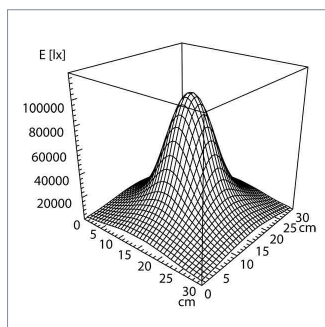
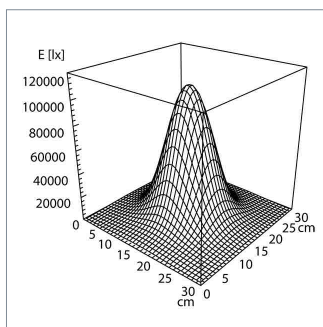



fitted with	LED - Energy efficiency category A+
Illuminancefield @ 100 cm	18 cm, (7 in)
illuminance @ 100 cm	100 000 lx
color rendering index (CRI)	> 95
colour temperatur	3700/4300/4700 K
work equipment	electronic converter
mains lead	3 m US
luminaire body	polyamide (PA)
weight (net)	20 kg, (44 lb)
Power consumption	40 W
usage	keypad at luminaire head
balance of articulation joints	spring
class of protection	I
Accessory	sterilizable handle
norms	EN 60601-1, EN 60601-2-41
special features	3 color shades, 4 dimming levels, Diamond optics, Focusable, High-quality arm system, sterilisable grip, maintenance free
Fastening	roller stand
System of protection	IP 20 (43)
order number	D15918000 - pure white



light distribution

