

Surgical light

AIM-200 OR

The right light for surgical procedures.

Philips Burton's new AIM-200 OR provides versatility, amazing illumination, unparalleled aesthetics and many more features that make it the right light for any procedure. Delivering true rendition of colors, this light is ideal for long hours of use with three cool 35-watt IRC halogen bulbs – each rated with a 1400-hour average bulb life. The AIM-200 OR is the first Operating Room light that has floor, wall, single- and double-ceiling mounts available. With its 360° limitless arm-and-mounting-system-rotation around the vertical axes on the single ceiling models, the AIM-200 OR is the most versatile and practical light for the Operating Room environment.

The AIM-200 OR is the most versatile and practical light for the Operating Room environment delivering 360° limitless arm-and-mounting-system-rotation around the vertical axes on single ceiling models,

Features

- 90,000 lux (8361 fc) at 1 meter
- 3700 K color temperature
- CRI (Color Rendering Index) of 96
- Larger and adjustable light pattern
- Unlimited rotation and maximum reach of 63" (160 cm)
- Light field diameter: 10" - 12" (25 cm - 30 cm)
- Depth of illumination: 47" (119 cm)
- Adjustable focusing by rotating center handle
- UL/IEC 60601-1, IEC 60601-1-2, EN/IEC 60601-2-41 and CAN/CSA C22.2 NO. 601.1 M90 certified
- CE marked
- 5-year limited warranty
- Assembled in USA

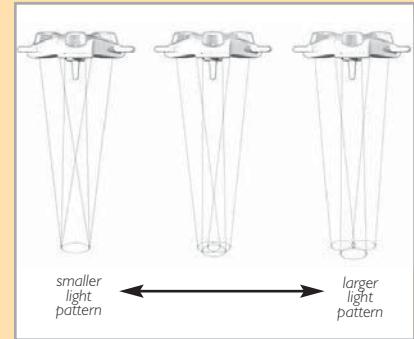

Larger and adjustable light pattern

The multiple reflectors of the AIM-200 OR can be tilted by rotating the sterilizable light handle to adjust the size and pattern of the light to the working area.



Light pattern free of cast shadows

The AIM-200 OR has a unique Y-Shaped design, which facilitates placement of the lighthead around the physician's head minimizing the obstruction of light into the surgical field.

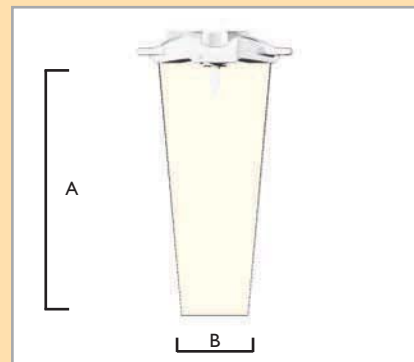

Depth of Field / Beam Diameter

		cm	in
A	Depth of field	119	47
B	Beam diameter D10	25	10

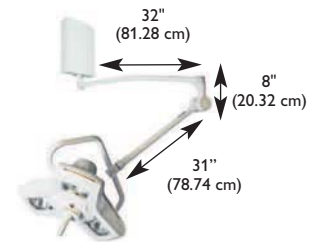
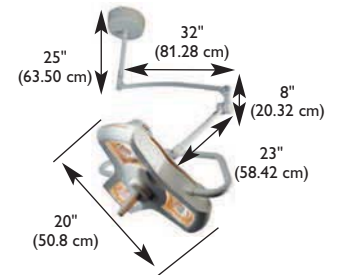
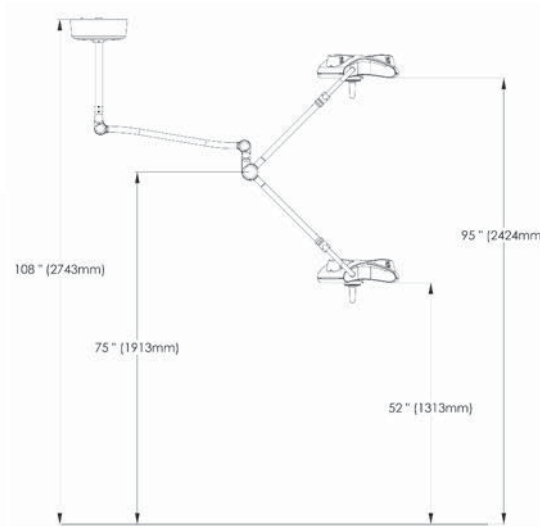
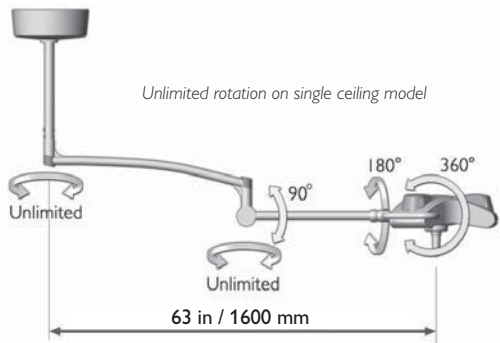
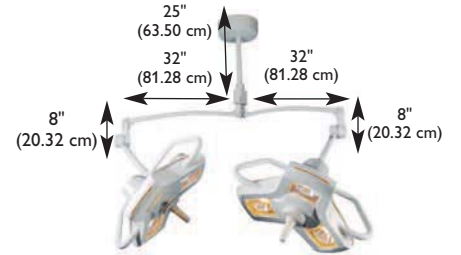
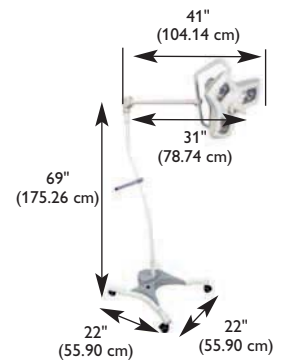

AIM-100 model shown to illustrate floorstand, single ceiling mount, double ceiling mount and wall mount configurations

Unlimited rotation and maximum reach

The AIM-200 OR's 360° limitless arm-and-mounting-system-rotation around vertical axes on single ceiling models is a key feature previously available only on more expensive OR lights. The arm system also provides a maximum reach of 63" and diameter of 10", allowing it to illuminate the patient from head to toe with no drift.

Ordering information

120V Model	230/240V Model	230V SP Model*	100V Model	Description
A200FL	A203FL	A202FL25	A201FL	Floorstand
A200SC	A203SC	A202SC25	A201SC	Single ceiling mount
A200DC	A203DC	A202DC25	A201DC	Double ceiling mount
A200W	A203W	A202W25	A201W	Wall mount
Accessories				
1017111PK				AIM-200 OR replacement bulbs, 3/box
1017040				Sterilizable / autoclavable handle
0008100PK				Light handle covers, sterile, 25/box
1017084				42" drop tube

*SP Model refers to Spanish Language Manuals.